

Swimming program

Summary

1. CONVENTIONS	6
2. STARTING	7
2.1. Introduction	7
2.1.1. Pod installation	7
2.2. Switching on and choosing the program	7
2.3. Timing	10
2.3.1. Start of first race	10
2.3.2. Finish of first race	10
2.3.3. Printing of ranking	10
2.3.4. New race	10
2.3.5. False start	10
2.3.6. Impulse 'from keyboard'	11
2.3.7. False impulse (to be annulled)	11
2.3.8. Finish	11
2.3.9. Quitting timing	11
3. PROGRAM CHARACTERISTICS	12
4. TIMING	13
4.1. Functional context	13
4.2. Terminology and peculiarities	14
4.3. Legend for graphic symbols	14
4.4. Starting a session	15
4.5. 'Environment' configuration	15
4.5.1. Setup type	15
4.5.2. Lanes present	16
4.5.3. Configuration session	16
4.6. Race	17
4.6.1. 'Trial' configuration	17
4.6.2. Empty lanes, disqualifications and withdrawals	18
4.6.3. Starts	18
4.6.4. False start	18
4.6.5. Automatic line Lock	18
4.6.6. Transits and finish	18
4.6.7. Missing impulses	19
4.6.7.1. Main events	19
4.6.7.2. Backup impulses	19
4.6.8. Printing of ranking	19
4.7. Functions	20
4.7.1. Annulment of Start	20
4.7.2. Annulment of impulse	20
4.7.3. New heat	20
4.7.4. Modifying List (heats)	21
4.7.5. Info	21
4.7.6. Modifying Start	21
4.7.7. Modifying Lap	21
4.7.7.3. Modifying times	22
4.7.7.4. Entering of times	22
4.8. Displayboard management	22

4.8.1.	Normal functioning	23
4.8.2.	Automatic queuing up	23
4.8.3.	Manual queuing up	23
4.8.4.	Disabling of displayboard	23
4.9.	Lock keys	23
4.10.	Holdoff time disactivation keys	24
4.11.	Quitting timing	24
4.12.	Printout of time events	24
5.	PRINTING TIME OF DAY	28
6.	RANKINGS AND OTHER PRINTOUTS	29
6.1.	Print/Show ranking	29
6.2.	Other printouts	30
6.3.	Printout and Visualization mode	30
6.4.	Print/Show climatic data	30
6.4.1.	View current climatic data	30
6.4.2.	View current wind data	31
6.4.3.	Print climatic data	31
7.	STARTS MANAGEMENT	32
8.	SYNCHRONIZATION	33
8.1.	Synchronization	33
8.2.	Modify synchronization value	33
8.3.	Synchronization verify	33
8.4.	Segnal	33
9.	DISQUALIFICATIONS	35
10.	DOWNLOAD DATA TO PC	36
10.1.	Off-Line data transmission	36
10.2.	On Line data output setup	36
10.3.	Data output protocol	37
11.	UPLOAD DATA FROM PC	38
11.1.	Upload of lists from PC	38
11.1.1.	Upload of competitor lists from PC	38
11.1.2.	Upload groups structure from PC	38
11.1.3.	Upload of start lists from PC	38
11.2.	Print out lists	39
11.3.	Delete lists menu	39
11.3.1.	Delete competitor name lists	39
11.3.2.	Delete groups structure	39
11.3.3.	Delete start lists	39
12.	REI2 SETUP	40
12.1.	Software setup	40
12.1.1.	Print Time of Day	40
12.1.2.	Time accuracy	40
12.1.3.	Manual threshold times	41
12.1.4.	Start threshold times	41
12.2.	Hardware setup	42
12.2.1.	LinkGate channel	42
12.2.2.	Printer	42

12.2.3.	Keys Beep.....	42
12.2.4.	Display contrast.....	42
12.2.5.	Linkgate transmission length.....	42
12.3.	Serial ports setup.....	43
12.4.	Printout Stopwatch setup	43
13.	DISPLAYBOARD SETUP.....	44
13.1.	Virtual Scoreboard	44
13.1.1.	Default Configuration.....	44
13.1.2.	Free configurations.....	46
13.2.	Visualization pause	49
13.3.	Serial speed of displayboard	49
13.4.	Spot program.....	50
13.5.	Visualization nation	50
13.6.	Configuration line 485	50
13.7.	Visualize time without points	50
13.8.	Max num in RollRank.....	50
13.9.	Displayboard available.....	50
13.10.	Vis. delay dis./tick.....	51
13.11.	Displayb. Trans.length check.....	51
13.12.	Visualization pause RollRank.....	51
14.	INPUT LINES SETUP	52
14.1.	Physical/Logical Channel Assignment	52
14.1.1.	Main line and key Assignment.....	52
14.1.2.	Radio Channel Assignment.....	52
14.1.3.	Linkpod Channel Assignment.....	53
14.2.	Lines holdoff times	53
14.3.	Lines exclusion configuration.....	54
14.4.	Lines N/O N/C configuration.....	54
14.5.	Noise filter principal lines.....	54
15.	SPEED BASES SETUP.....	56
16.	LINKGATE DATA UPLOAD.....	57
17.	LINKGATE RADIO SIGNAL LEVEL	58
18.	TIME CALCULATOR.....	59
18.1.	Normal	59
18.2.	Extended (day management).....	59
19.	MODEM	60
20.	RECHARGE BATTERIES.....	61
20.1.	Discharge/recharge.....	61
20.2.	Immediate recharge.....	61
20.3.	Break	62
21.	RACE MANAGEMENT	63
21.1.	New race	63
21.2.	Delete/Recall stored race	63
21.3.	Continue current race	63
21.4.	Clear all memory.....	64
22.	MODIFY BASIC CONFIGURATION	65

23. LINES STATUS	66
24. PRE-SET CONFIGURATIONS	67
24.1. Pod configurations	67
25. REI2 – PC COMMUNICATION PROTOCOLS.....	69
25.1. From PC	69
25.1.1. List of athletes’ names and nationalities	69
25.1.2. Start lists	70
25.2. For PC	72
26. MENU STRUCTURE.....	73
26.1. Initial menu	73
26.2. Race menu.....	73
27. EDITING HISTORY	77

Index of Figures

Figure 1– Display example:Ready at the Start.....	9
Figure 2 – Display example:After first finish	10
Figure 3 – Legend for graphic symbols	15
Figure 4 – Example of printed strip: Headings on printed strip.....	25
Figure 5 – Example of printed strip: Event deleting	26
Figure 6 – Example of printed strip: Event modification	26
Figure 7 – Example of printed strip: Acquisition of a transit	26
Figure 8 – Example of printed strip: Acquisition of a false Start	27
Figure 9 – Example of printed strip: Triple manual acquisition.....	27
Figure 10 – False start evaluation.	41

1. Conventions

In this manual the keys to be pressed are shown inside angled brackets. For example, press <**F1**> means the yellow key marked F1, while the options proposed by REI2 are indicated in bold type.

A time which is shown in *italics* on the display indicates that this time is running on the stopwatch.

An underlined figure indicates that the blinking cursor is in that position and the stopwatch is waiting for input.

2. Starting

2.1. Introduction

The best way to learn to use Microgate's REI2 stopwatch is to begin trying. Bear in mind that there is no sequence of keys which can damage your stopwatch. However, make sure you read the 'user manual' carefully before connecting any accessories.

This first chapter will guide you step by step through the management of a short swimming competition with one race of 50m and one of 100m in a 25m pool with manual time-taking. For the sake of simplicity, we will use only 3 lanes (from 1 to 3).

During this first time of use we will simulate the various Start impulses using the key <STA> and external buttons to simulate the turns and finishes.

We assume that no displayboard is connected.

2.1.1. Pod installation

We connect a single Pod to REI2 with the dedicated cable and enter buttons in the lines 1, 2 and 3. The Pod must have the address 0.

2.2. Switching on and choosing the program

We start, of course, by switching on the stopwatch with the relative switch. For a moment the message ---SYSTEM BOOTING --- appears on the screen, and then some words of presentation and the software version installed.

If REI2's internal clock has not been synchronized or has in some way lost synchronization, you are informed of this (**The system has lost synchronization**). You are also informed if the data in the memory is no longer valid (**ATTENTION MEMORY CORRUPTED**). Refer to the **User Manual** chap. **First switching on** for the relative instructions.

The information about the software version is also shown on the printout. When this phase is over, the first menu appears.

Hh:mm:ss.d

A:New race
 B:Delete/Recall stored race
 C:Continue current race
 D:Clear all memory
 A B C D other

Let's select the **New race** option with <F1>. On the printout the choice we have just made will be shown, that is, NEW RACE, and REI2 asks us what type of race we are going to time.

Hh:mm:ss.d

Select the program:
 A:Single starts
 B:Group starts
 C:Simple stopwatch
 D:Parallel
 A B C D other

Pressing <F5> takes us to the second program choice display.

Hh:mm:ss.d

Select the program:
 A:Show jumping
 B:Swimming
 C:PC-ONLINE
 D:Dual Timer
 A B C D other

And we press <F2> for **Swimming**.

Hh:mm:ss.d

A:Clear previous configuration
 B:Keep last race configuration
 A B

We select <F1> for **Clear previous configuration** and confirm our intention to delete the configuration with <F4>.

Hh:mm:ss.d

Select the configuration:
 A:Manual
 B:Automatic 1 end
 C:Automatic 2 ends
 D:Automatic 2 ends + start
 A B C D other

Stored in it, REI2 has various standard configurations for the various sports disciplines. We select **Manual** with the key <F1>.

Hh:mm:ss.d

A:Timing
 B:Printing of times
 C:Ranking and other printouts
 D:Start management (Disab.)
 A B C D other

The selection made is shown again on the printed strip. Now we are ready to start the **Timing** session by pressing <F1> again.

Now we are asked to specify the lanes not present in the pool. We exclude all the lanes from 4 to 10 by pressing the keys <4> <5> <6> <7> <8> <9> <0> (Remember that <0> stands for lane 10). The various **P**s turn off. Press <ENT> to confirm.

```
Hh:mm:ss.d
SESSION CONFIGURATION
Enter Bib : No
Length pool: 25
Headline: : No
Modify lanes
Upload start lists
↑ ↓ Edit Edit.L Conf.
```

We accept the data proposed by pressing <F5>

```
Hh:mm:ss.d
TRIAL CONFIGURATION
Laps: 1( 50) Heat: 1
Rearm: 10 Style:
Phase: Sex:
Step H: Increment
↑ ↓ ↔ Edit Conf.
```

We also accept this data by pressing <F5>

From this moment on, the REI2 display no longer operates in 'text' mode but switches to 'graphic' mode.

Let's pause for a moment to analyze in Figure 1 what now appears on the display.

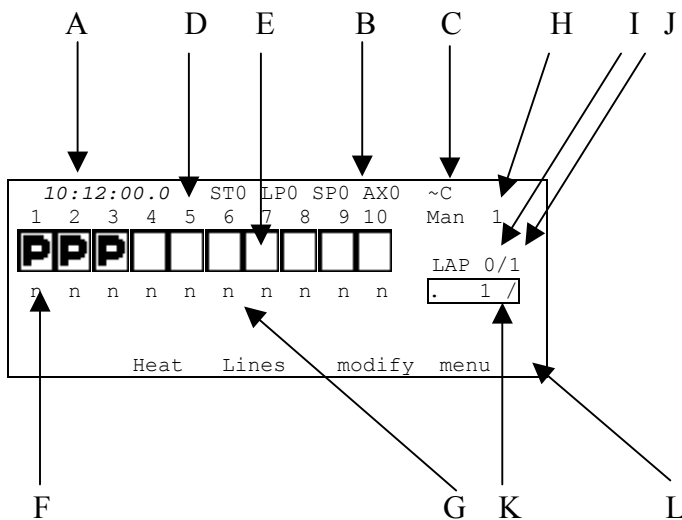

Figure 1– Display example:Ready at the Start

In the various positions we see:

- Running time of day
- Status of lines
- Power status
- The lane number
- The graphic symbols indicating the lane status
- The number of any late laps
- The main data of the 'manche':
 - Number
 - Lengths swum by the leader
 - Total lengths
- The displayboard indicator
- The options which can be activated with the function keys.

2.3. Timing

2.3.1. Start of first race

We can now start our race by pressing the key <STA>. The heading, the time of day of the start and the meaning of the different columns are printed on the printed strip. The graphic symbol varies between lane ready and lane not ready. When the programmed rearm time ends, the symbol changes to ready for finish (□).

2.3.2. Finish of first race

To simulate the finish of the first race, we close line 1 of the Pod. The symbol changes to finished in first place (1). Running time on the display stops while the time difference from the first begins to run (see Figure 2) and the net time is printed on the printed strip.

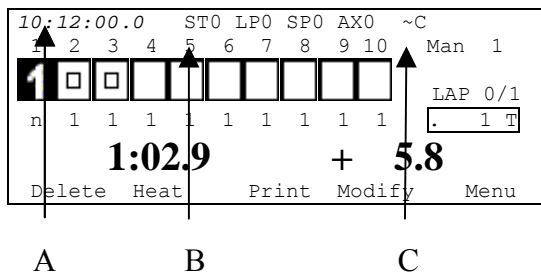

Figure 2 – Display example:After first finish

In the various positions we see:

- Symbol for first to finish
- The time of the first to finish
- Running time difference.

For the finish of the following competitors, we close the Pod lines 1 and 2. This changes the symbols for lanes 2 and 3 (2 3) and the relative times are printed.

2.3.3. Printing of ranking

To print the ranking, press the key <F3> **Print** and then the key <F2> **official**. The data specifying the race together with only the net times obtained is reprinted on the printed strip.

2.3.4. New race

To start the second race, press the key <F2> **heat** and again <F2> **new**.

As this is a 100m race, we must change the number of laps. Press <F4> **Modify** <2> and <ENT>. The total distance to be covered appears next to the laps. We return to timing with <F5>. We start the race with <STA>.

2.3.5. False start

Let's suppose that this start has to be annulled. To cancel, press the key <F1> **Delete** and immediately afterwards, the key <F2> **Start**. REI2 asks us to confirm that we want to cancel the start impulse. To confirm, press <F4> **Yes**, to annul press <F5> **No**. Indication that the start has been canceled is printed on the printed strip.

2.3.6. Impulse 'from keyboard'

We simulate the first turn of the competitors in lanes 1 and 2 by closing line 1 and then line 2 of the Pod. For some reason we do not receive the impulse from lane 3. To enter the impulse for the competitor in lane 3 manually, we press the key <STO>.

With **Press number**, REI2 asks which lane the impulse should be attributed to. We press the key <3>.

2.3.7. False impulse (to be annulled)

As soon as lane 3 is reset we close line 3 of the POD to simulate a new impulse. To annul this impulse, which we shall consider to be unwanted, press the key <F1> **Delete** and then the key <F3> **Lap**.

With **Press number**, REI2 asks for which lane the impulse should be annulled. and we press <3>. Now REI2 asks us to confirm that we want to cancel the impulse. To confirm, press <F4> **Yes**, to annul press <F5> **No**. Indication of the annulment is printed on the printed strip.

2.3.8. Finish

To finish the race we close the lines 1, 3 and 2 in succession and print the official ranking.

2.3.9. Quitting timing

Having finished our brief race, we quit the timing function by pressing the key <F5> to choose the option **menu**. The display has now returned to text mode.

3. Program characteristics

In the brief race illustrated in ‘Starting’, we have used only a minimal part of the function features offered by the ‘Swimming’ program. In the following sections the various configuration possibilities and the various operations to be performed for particular events will be analyzed.

REI2 stores all the events (start, intermediate, stop) and allows you to make all the modifications that may become necessary at any time, also of finished runs. The values that depend on the modified events (net time, lap time) are recalculated after each modification.

On the printout the start times, all the net times acquired and any modified time events (annulments, variations, re-assignments...) are shown.

Firstly the functions available within the Timing function will be illustrated. Then the possibilities which can be accessed from the program menu will be illustrated.

The various choices possible, both as regards the various menus and options and the various values which can be modified, are assigned each time by the 5 function keys <F1> <F2> <F3> <F4> <F5>.

If not otherwise specified, times are taken with an accuracy of 1/25,000 of a second; they are printed and displayed with an accuracy of 1/10,000. All the calculations are made at 1/25,000 and then net times are rounded up or down as requested.

To meet special requirements, times can be taken and stored at lower levels of accuracy and adjusted to the same level required by the competition (e.g. relay races timed at 1/10).



REI2 stores all the events but not net times. Storing all the events and calculating the results when they are needed allows maximum flexibility of race management, such as the modification of events for previous races, re-printing of the rankings of races already completed and the simultaneous management of two or more races.

To set the lane number 10, press the key <0>.



The start line must be connected to REI2's Start input. All the other lines must be connected to the **LinkPod**® system following the scheme given in chap. 24.1 Pod configurations (on p.67). If necessary, it is possible to take the time on 3 lanes by changing the logical channels associated with the main lines (lap, aux e stop) with the function 14.1 Physical/Logical Channel Assignment (on p.52).



As the use of the **LinkPod**® devices results in greater power consumption, we advise you to connect an external power supply to REI2, preferably an accumulator, to avoid dangerous voltages near the water.

This manual refers to version 1.07.9.

- **Modify**
 - **Start**.....4.7.6 Modifying Start 21
 - **Lap**.....4.7.7 Modifying Lap 21
 - **Info**4.7.5 Info 21
 - <<<<. allows you to return to main menu (in all submenus)
- **Menu**..... 4.11 Quitting timing 24
- <0>...<9>4.9 Lock keys 23
- <ALT>+<0>...<ALT>+<9> 4.6.2 Empty lanes 18

4.2. Terminology and peculiarities







Some terms in this manual as well as in the program are used differently from the way they are usually used in the other programs or could give rise to doubts about their meaning. Some of them are explained below.

By automatic acquisition is meant the acquisition of events by means of touchpads or automatic systems. By manual acquisition is meant acquisition by using manually controlled buttons. Unless otherwise stated in the regulations of the various national federations, nothing prohibits the connection of manual systems to lines reserved for automatic acquisitions or viceversa, or similarly the omission of the manual acquisition requested in automatic systems.

Trial: by trial is meant the races which take place during the same event. For the counting of race time, REI2 considers only the trial in progress. There is no function for adding together times of different trials. REI2 stores the various trials as if they were runs.

4.3. Legend for graphic symbols

REI2's swimming program makes extensive use of graphic symbols to indicate the status of the different lanes.

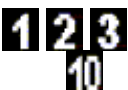
Symbol	Description	Meaning
	Empty square	The lane is ready to receive a LAP impulse
	Square with cross	Temporary lock on lane
	Double square	Impulse received on the line (appears for a very short time)
	Square with broken lines	Lane not present in pool
	Triangle with exclamation mark	Too great difference between electric and manual acquisition. (Blinks in alternation with another symbol)
	Double square	Lane is ready to receive final impulse (STOP)
	White number on black (from 1 to 10)	Competitor finished in position indicated







	Square with letter P	Lane with competitor ready to start
	Square with broken lines with letter A	Lane without competitor
	Square with cross and thick black border	Impulse acquired during Lock (appears for a very short time)
	Padlock	Manual lock on lane
	Bordered letter S	Competitor disqualified
	Outlined letter R	Competitor withdrawn

Figure 3 – Legend for graphic symbols

4.4. Starting a session

To begin a timing session (race), after you have chosen the option for the race a request appears asking you to select the program required.

This manual illustrates the functioning of the ‘Swimming’ program so press the key <F5> for **other** and <F2> for **Swimming**.

If a previously used configuration is stored and you intend to use it (automatisms, truncations, holdoff times...), press <F2> for **Keep last race configuration**.

If, on the other hand, you wish to change the configuration used, press <F1> for **Clear previous configuration**. To confirm that you wish to annul the configuration set, press <F4> for **Yes** and the function key corresponding to the new configuration to be used; in case of error, press <F5> for **No**.

Then to activate the session, press <F1> for **Timing**.

4.5. ‘Environment’ configuration

The characteristics common to all the trials which will be subsequently performed are specified. These settings, which remain constant for all the trials, will not be requested again.

4.5.1. Setup type

The first operation you are asked to make is to specify the setup you intend to use by choosing between the 4 different possibilities, that is:

- <F1> **Manual**: Only manual acquisition is managed
- <F2> **Automatic 1 end**: There are touchpads only at one end of the pool + manual acquisition at the same end
- <F3> **Automatic 2 ends**: There are touchpads at both ends of the pool, as with manual
- <F4> **Automatic 2 ends + start**: There are touchpads at both ends of the pool with, in addition, false start sensors

...other

- <F1> **3 Manual 1 end** (*): There are 3 manual time acquisitions for every lane

- **<F2> 3 Manual 2 ends** (*): The three manual time acquisitions are made at both ends of the pool.
- **<F3> Rowing** Only manual acquisition is managed

To access the configurations marked (*) you must pass to the second part of the menu by pressing **<F5>**. With these configurations activated, on the printed strip the times are shown with the indication **Rn**, where **n** is the progressive acquisition number for that point on that lane. The acquisition taken into consideration for the ranking is the middle one (see Figure 9 on p.27).

For details of configurations, see chap. 24 Pre-set configurations on p.67.

4.5.2. Lanes present

After selecting the setup type, you are asked what the lanes are. Press the key which corresponds to the lane number which is not in the pool (for example, for a setup with 8 lanes, press **<9>** for the ninth lane and **<0>** for the tenth). If you make a mistake, the lane can be reactivated by pressing the corresponding key again.

The lanes present are indicated with the symbol **P**, those absent with the symbol **□**.

When this phase is over, press **<ENT>**.

The lanes disabled during the event are printed on the printed strip.

4.5.3. Configuration session

In the third and last display, further general data about the event is requested.

The configurable data is:

- **Enter Bib.:** allows you to enable (**Yes**) or disable (**No**) the request for competitor numbers
- **Length pool:** allows you to change the length of the pool (**25, 50, 33**) or to enter any other value. In the Rowing configuration the distances available are **250** and **500**
- **Heading:** allows you to enable (**Yes**) or disable (**No**) the printing of headings
- **Modify lanes:** With this choice you return to the phase 4.5.2 Lanes present(see p.16).
- **Upload start lists** The stopwatch puts itself on standby for the reception of the start lists.

When you have entered configuration, the following function keys are activated:

- **<F1> ↑:** to move the cursor up
- **<F2> ↓:** to move the cursor down
- **<F3> Modify:** to change the setting indicated by **◀** ; each time you press, one of the possible values is activated
- **<F3> Select *** to access the Receive start list menu
- **<F4> Modify L:** allows you to set a length different from the ones proposed
- **<F4> Print *** to print the downloaded start lists
- **<F5> Conf.:** to confirm the data entered and return to the previous menu.

(*) indicates a case in which the cursor is positioned on Receive start list.

4.6. Race

4.6.1. 'Trial' configuration

This information is requested for each new heat. It is not necessary to enter all the values requested, but it is essential to enter the correct number of **Lap** and the correct **Refit** time.

The configurable data is:

- **Lap:** to enter the number of impulses expected in the race. Impulses will not be accepted for a lane which already has a number of impulses equal to the number of laps specified.
- **Refit:** to enter the time, in seconds, in which the line remains deactivated after receiving an impulse. The impulses received during rearm time are lost.
- **Phase:** optional value of the phase in progress. The possible phases are: No value, Preliminary qualifications, Final stage qualifications, Quarter finals, Semifinals and Finals.
- **Heat:** allows you to enter a reference number for the race in progress. This number is automatically increased or decreased with each new heat.
- **Style:** optional style value. The choices possible are: Crawl, Breaststroke, Backstroke, Butterfly, Dolphin, Mixed. For Rowing configuration C1, C2, C4, K1, K2 and K4.
- **Sex:** optional value. The choices are: No value, Male, Female, Mixed.

Phase, Style and Sex are printed on the printed strip before the race they refer to only if the 'Print heading' option is enabled. See chap. Configuration session on p.16.

The enabled function keys are:

- <F1> ↑: to move the cursor up
- <F2> ↓: to move the cursor down
- <F3> ⇄ allows you to pass rapidly from one column to the other
- <F3> **Modify:** to change the setting indicated by ◀ ; each time you press, one of the possible values is activated
- <F5> **Conf.:** to confirm the data entered and return to the previous menu.

If event management is only manual (as in the configuration Manual or Rowing), when the number of laps is set on the last line of the display you are asked if you want to use special lengths. If you choose **Yes**, instead of using the length of the pool multiplied by the number of laps, the special length chosen is used.

The default settings are:



1st lap 50
2nd lap 100
3rd lap 200
4th lap 400
5th lap 800
6th lap 1500

For example, if the pool length is set as 50 and the N° laps as 5 and special lengths is chosen, instead of 500 metres (= 50 * 2 * 5) you have 800 metres.

To modify special lengths refer to chapter

4.6.2. Empty lanes, disqualifications and withdrawals

REI2 allows you to intervene on each lane, declaring that the competitor for that lane is absent, withdrawn or disqualified. When the key <ALT> is pressed together with the key for the lane concerned, the following functions appear on the last line of the display:

- **Absent/Present** the lane is declared absent or present. The symbol  appears next to the empty lane.
- **Disqualification/Reinstatement** the competitor is disqualified or reinstated. The symbol  appears next to the disqualified lane.
- **Withdrawn** the competitor is declared as not finished. The symbol  appears next to the not finished lane. To reinstate the competitor you need only annul the last lap.

Lane information can be changed at any moment during the race or when it has finished.

4.6.3. Starts

The start signal is acquired on the logical line **START**. When the start is acquired, the symbol next to the different lanes is replaced by the symbol for logically locked line (.

Manual impulses remain deactivated for 2 seconds after the start.

The time of day of the start and the headings of the various columns are printed on the printed strip.

If there is a false start, it can be annulled by pressing the key <F1> for **Delete**, then the key <F2> for **start** and finally by confirming with **F4> Yes** when you are asked **Sure?**.

The annulment is indicated on the printed strip.

4.6.4. False start

The time limits within which false starts can be acquired can be set with the function 12.1.4 Start threshold times(see p.41). If a false start is acquired, a false start notification, the lane responsible and the anomalous margin by which the start is early or late are printed.



Acquisition of false times is active only in the configuration **Automatic 2 ends + START**.

4.6.5. Automatic line Lock

The lines remain in Lock status from the moment of the start and after the acquisition of an impulse for the rearm time specified with the function 4.6.1 'Trial' configuration (see p.17). Computation of rearm time is independent for each lane and is calculated from the last event acquired on that lane.

During this period, all the events acquired on the line are discarded. Locked line status is indicated with the locked symbol (). When the rearm time is over, the lines become sensitive again and this is indicated by a change in the symbol.

4.6.6. Transits and finish

The lines are ready to acquire a transit event when the symbol  appears, and a finish when the symbol  appears. Lanes which are about to receive a number of impulses equal to those specified in the value **Lap** in 'Trial' configuration (see chap. 4.6.1 on p.17) are considered to be at the finish.

When the competitor in such a lane has finished the trial, his/her position appears written in white on a black ground (**1 2 3** ... **10**).

The winner's time appears on the penultimate line of the display. The time difference from the first, which begins to run after the first competitor has finished, appears on the right on the same line. The time difference stops for two seconds for each finish.

4.6.7. Missing impulses

During the timing session, for some reason some events may be missing. The operational mode is different according to whether the missing events are 'main' or 'reserve'.

4.6.7.1. Main events

The key <STO> can be used to generate an impulse to be received as a main impulse. After pressing this key, when REI2 tells you to **Press number**, indicate the lane to which to assign the impulse generated by pressing its corresponding number (<0> for lane 10).

Impulses generated in this way can also be assigned to lines in lock status and be correctly received. The new lock time is calculated starting from the impulse entered in this way. If you make a mistake, the impulse can be deleted by pressing the key <F5> **ANNULL**.

4.6.7.2. Backup impulses

If a 'main' event is acquired on a line without a corresponding 'backup' event being acquired and of course if it is not canceled, REI2 automatically generates the missing event after a period specified with the function 12.1.3 Manual threshold times (on p.41). The time event entered has the same value as the 'main' event.

4.6.8. Printing of ranking

When the heat is finished, to 'label' it as terminated the ranking must be printed.

You can choose from:

- **Heat.** the ranking is based on two or more heats. REI2 asks you to enter the number of races from which to make the ranking
- **Official** to print the official ranking of the single race
- **All** to print the official ranking of all the races made
- **Copy** to print a copy of the single race with all its transits.

When rankings are printed, the following information will be given on the printed strip in this order:

- the data characterising the heat, such as the race number, the heat number and the number of acquisitions requested and, if required, (see chap. 4.5.3 Configuration session on p.16), descriptive data
- any 'transit' times with the indication of the transit number and the distance covered
- the finish order with the relative heading **Finish**.

4.7. Functions

4.7.1. Annulment of Start

To annul a start, press the key <F1> for **Delete** and immediately after, the key <F2> for **Start**. To confirm that you intend to delete the start, press the key <F4> for **Yes**. If you make a mistake, you can abandon deletion by pressing <F5> for **No**.

Indication of annulment is printed on the printed strip.

4.7.2. Annulment of impulse

To cancel an impulse acquired from the main lines¹ (touchpads), press the key <F1> for **Delete** and immediately after, the key <F3> for **Lap**.

At this point REI2 asks you to indicate the number of the line whose event you want to cancel. After selecting the line number, when you press the corresponding key, 'Ann lap.xx Cor.yy?' appears on the display, where xx stands for the number of the last lap taken and yy the lane number. To confirm that you intend to delete the event, press the key <F4> for **Yes**. If you make a mistake, you can abandon deletion by pressing <F5> for **No**.

If the key <ALT> is pressed, the words (Manual Ev.) appear. If <ALT> is kept pressed down and at the same time <F4> for **Yes** is pressed, only the manual event is annulled.



If an electronic event which has generated a manual impulse automatically is annulled, the manual impulse is also annulled.



If a manual event which has generated an electronic impulse automatically is annulled, the electronic impulse is also annulled.

However, if you have to annul two independent events, one manual and the other automatic, you must first annul one and then the other.

If instead of annulling the last lap you want to annul another lap, you must enter the correct lap number. For example, if the competitor in lane 5 has already done 4 laps but you realise that the second lap is a false impulse, you must press <F1> for **Clear**, <F3> for **Lap**, then key 5 for the lane, next key 2 for the lap number and finally confirm with <F4> **Yes**. Not only is the Lap 2 event annulled, but automatically Lap 3 becomes Lap 2 and Lap 4 becomes Lap 3.

Indication of annulment is printed on the printed strip.

4.7.3. New heat

When a heat is finished, to go on to the next heat press the key <F2> **Heat** and immediately after, the key <F2> **New**.

This brings up the display for the request for data identifying the heat (see chap. 4.6.1 'Trial' configuration on p.17).

If the heat in progress is considered not yet finished, either because not all the competitors have reached the finish or because the ranking has not been printed, the message **Heat not termin** appears. To confirm the new heat, press <F4> **Yes**, to annul, press <F5> **No**.

¹ If the configuration 'Manual' has been chosen, the impulses acquired are considered as having come from the touchpads.

4.7.4. Modifying List (heats)

This function allows you to view and call up previously finished heats. The following information is printed on the display:

- **Addr.** Progressive index number
- **Heat** Heat number
- **Phase, Sty, Sex:** The characteristics of the heat as specified with the function 4.6.1 'Trial' configuration (see p.17)
- **Sta** The filled in small circle indicates that there is a start signal for this heat, the empty small circle, that there is no relative start signal
- **Fin** The filled in small circle indicates that all the competitors expected have finished the heat, the empty small circle that someone has not finished the heat.
- **Rnk** The filled in small circle indicates that the ranking for this heat has been printed, the empty small circle that it has not been printed.

The enabled function keys are as follows:

- <F1> ↑: to move the cursor up
- <F2> ↓: to move the cursor down
- <F3> **Recall:** to retrieve the heat indicated by the symbol ◀ . You are asked to confirm that you intend to retrieve the heat with **Recovery race**. Press <F4> **Yes** if you want to retrieve the heat, <F5> **No** if you do not, and to continue with the heat in progress
- <ESC> **QUIT:** to return to the previous menu.

4.7.5. Info

It is possible to find out the number of impulses acquired on the main lines and reserve lines of each lane, as well as the relative final times and corresponding time differences by pressing the key <F4> for **Modify** and immediately afterwards, the key <F4> **Info**. You are asked to indicate the lane number you intend to consult.

4.7.6. Modifying Start

This function allows you to change the start time of each heat. The start times are changed for all the lanes.

4.7.7. Modifying Lap

It is possible to change the final time acquired for each lane. To make these changes, press the key <F4> **Modify** and immediately afterwards, the key <F3> **Lap**.

The data of the various competitors in their finishing order is shown. The following data is given in the different columns:

- **Num.** the competitor's
- **Rnk** position in ranking
- **La** lane occupied
- **Lap** number of laps completed (automatic strokes)
- **Principal** the time acquired on the main lines
- **Backup** time difference compared with reserve timing.

The enabled function keys are as follows:

- <F1> ↑: to move the cursor up
- <F2> ↓: to move the cursor down
- <F3> **Modify**: to access the time editing function for the competitor indicated by the symbol ◀ . See chap 4.7.7.3 Modifying times (p.22)
- <F4> **Inser.:** to access enterion of the missing lap/final times function for the competitor indicated with the symbol ◀ , see chap. 4.7.7.4 Entering of times on p.22
- <F5> **Ass.B** to give the main acquisition the value of the ‘backup’ acquisition
- <ALT><F4> **Detail**: to access the function 4.7.5 Info (p.21) for the competitor indicated by ◀
- <ESC> **menu**: to return to the previous menu.

4.7.7.3. Modifying times

This function, accessed from the previous menu, allows you to change the time acquired for the competitor indicated by the symbol ◀ .

The enabled function keys are as follows:

- <F1> **N.Lap** allows you to modify the lap number you are interested in
- <F4> **Ass.B** allows you to enter the value of the manual acquisition as an electronic acquisition
- <F5> **QUIT** to quit this function.

Indication of the change made is printed on the printed strip.

4.7.7.4. Entering of times

This function, accessed from the previous menu, allows you to enter any missing lap/final times for the competitor previously selected.

You are asked to specify the lap number required and to indicate the number of the last lap acquired for the competitor. Any lap number can be entered provided it is greater than zero and equal or less than the number of laps in the trial.

When you have entered the lap number required and pressed <ENT>, you are asked for the new time to enter. If the lap entered precedes one already acquired, REI2 proposes the time of the next lap. If there are no laps stored, 0 is proposed.

If a lap number higher than the next one acquired is entered, REI2 enters all the missing laps with the same time.

Note: lap to be entered 4, last lap acquired 2, lap 4 and lap 3 will be entered with the same time.

All the times entered are printed on the printed strip.

4.8. *Displayboard management*

REI2’s management of the displayboard/displayboards is very sophisticated. The configuration options of the displayboards installed is illustrated in section Displayboard Setup on p.44. In this section their management during timing will be illustrated.

Inside the ‘displayboard indicator’ (see Figure 1 on page 9), the competitor number shown to the public is displayed with the indication as to whether the time is a running time (revolving bar), a net time (T), a lap time (L) or whether a previous event request is being entered. A series of ---- shows when the displayboard is switched off.

If the frequency of the acquisition of events to be displayed is too rapid for them to be easily read, REI2 delays data display for a time preset in the configuration.

4.8.1. Normal functioning

During a normal timing session, running time and the rotating bar are shown on the displayboard.

At each transit, the transit times of the various competitors are shown as they are acquired provided they are on the same lap as the leader. In other words, the transit times of competitors who are one or more acquisitions behind the leader are not shown.

The passing of the pre-set display time is shown by a bar between the competitor's number and the letter T, which becomes shorter as the time passes.

4.8.2. Automatic queuing up

Any data to be displayed before display time is over is queued up and shown afterwards.

4.8.3. Manual queuing up

When some of the competitors have reached the finish, their results can be shown again on the displayboard by pressing the key **<Displayboard>**. The data queued up in this way will be shown in the same way as for automatic queuing up while the data not yet displayed will be canceled.

The function Disabling of displayboard empties the queue of events to be displayed.

4.8.4. Disabling of displayboard

To deactivate the displayboard output so that no communication appears, press the **<ALT>** + **<Displayboard>** keys simultaneously. In the displayboard indicator the sign '-----' appears and the red led of the key begins to blink rapidly (about two blinks a second). To reactivate the displayboard, press the **<ALT>** + **<Displayboard>** keys again. The indicator stops blinking.

4.9. Lock keys



The management of the locks is different from that of the other REI2 programs. It is possible to prevent reception of an impulse on a line simply by pressing the corresponding number (0 for lane 10). On the display, the padlock symbol (🔒) appears next to the relative line. To re-enable the line, press its number again. Any impulses received are automatically canceled.

The two **<LCK>** keys have similar function features. The only difference is that, while the **<LCK>** key over the **<Stop>** key operates only on the stop line, the key over the **<Start>** key can be configured in whatever way the user likes (see section Lines exclusion configuration on p.54)

When activated by pressing, the red led corresponding to the button pressed begins to blink and the symbol # appears in front of the number of impulses in the memory.

All the impulses acquired at the locked line are stored.

Pressing a second time on the LCK key reactivates the line (and turns off the relative led). At this point, if at least one event has been acquired, the message '**Annul.nn events xxx ? Yes No**' appears on the last line of the display, where nn is the number of events acquired and xxx is their type. Reply **Yes** with **<F4>** to delete irreversibly the events acquired. Reply **No** to deal one by one with the events in question, deciding whether to annul them or assign them to an athlete.

If necessary, it is possible to reactivate the lock, once again with the <LCK> key, without losing any events. The next time the <LCK> key is pressed, you are offered the possibility of managing both the events acquired in the previous lock phase and those in the latest one.



Note that the lock keys function on all the inputs (line, LinkPod ©, radio) assigned to the blocked logical channel. However, they have no effect on the line keys.

4.10. Holdoff time disactivation keys

The two <Rearm > keys have similar function features. The only difference is that, while the <Rearm> key over the <Stop> key operates only on the stop line, the key over the <Start> key can be configured in whatever way the user likes (see section Lines exclusion configuration on p.54).

Pressing the key once annuls the waiting time set for the lines on which it is configured. In this way REI2 can be set up to receive impulses without waiting for the end of the holdoff time set (see section 14.2 Lines holdoff times on p.53). Annulment of holdoff time, shown by the blinking of the led on the key, remains active until the <Rearm> key is pressed again; the key has no effect on lines in a state of automatic lock (☒) or manual lock (🔒).

4.11. Quitting timing

To return to the competition menu at the end of the timing session press the <F5> key for **menu**.

It is possible to quit the timing menu, make changes and return to timing also during the race. Of course, all the data is retained.

If some events, for example a stop, are acquired when you return to the timing function, the message '**Some events have been acquired. Do you want the events acquired to be deleted?**' appears. To cancel the stored events press the <F1> key and then confirm the decision to delete with the <F4> key for **Yes**. If you press <F2> you will return to timing, with the events ready to be managed.

4.12. Printout of time events

REI2 prints all the events, results and operations performed on the printout. When there is a start, a few lines of information about the race in progress are printed, as in the following example:

```

Race n.: 1
Heat.: 1
Laps: 4 Refit: 25

St 6      M 6      Key
START 16:32:12.9_221

Rank
| lane
| | lap  time
| | |
| | |
| | |

```

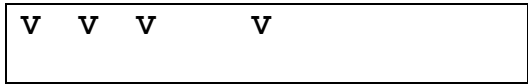



Figure 4 – Example of printed strip: Headings on printed strip

Other 'informative' notes concern deleting of an event:

```

AN 1      M 6   Key
  START 16:32:12.9_221
    
```

Figure 5 – Example of printed strip: Event deleting or modifying an acquired event:

```

An. 3     M 6   Key
  STOP 16:40:25.7_747

CC 3      M 6   Key *M*
  STOP 16:40:24.7_747
    
```

Figure 6 – Example of printed strip: Event modification

For every intermediate or final impulse acquired, a line containing the values of the result obtained is printed.

Let's have a detailed look:

	A	B	C	D	E	F
	↓	↓	↓	↓	↓	
1	4	3	2:59.6			
--	4	3	2:59.7		man.	
2	5	3	3:01.4			
--	5	3	3:01.3		man	
...						
RR	1	2	3:02.4			
--	1	2	3:02.4		man	

Figure 7 – Example of printed strip: Acquisition of a transit

- Place in ranking, printed only for main acquisitions for competitors with complete number of laps; for backup acquisitions, '—' appears
- Lane number
- Number of laps completed
- Time acquired with precision set
- Indication **Man** for backup acquisition, **Aut.** For automatically generated, **Key** for <STO> key
- Competitor one or more laps behind the leader.

If a system for the acquisition of false starts is installed, and acquisition is made, this is indicated on the printed strip:

```

FALSE START HEAT N. 1
ADVANCE - 0.14

FALSE START HEAT N. 4
DELAY + 0.01

```

Figure 8 – Example of printed strip: Acquisition of a false Start

If triple manual acquisition is used, the various acquisitions made are shown on the printed strip:

```

-- 1 1 21.8 R1
 1 1 1 21.9 R2
-- 3 1 22.2 R1
-- 2 1 22.2 R1
 2 3 1 22.3 R2

```

Figure 9 – Example of printed strip: Triple manual acquisition

5. Printing time of day

A complete record of time events can be consulted on the display or printed, or printing can be limited to the period between two times of day chosen by the user.

Options available:

- <ESC> to quit this choice
- <ENT> to show the list on the display
- <ALT>+<ENT> to print the time events
- <F1> allows you to change any initial value
- <F2> allows you to change any final value
- <F3> reduces to zero the initial and final values
- <F5> returns you to the menu.

If you decide to consult the time events on the display, you have the possibility of scrolling the entire time event list or extracting a part of it by setting the competitor number and/or run. It is also possible to print a single time event line.

Options available:

- <ESC> returns to the choice of time limits
- <F1> scrolls one event back on the list
- <F1> when pressed for over 2 seconds, scrolls quickly back up the list
- <F2> scrolls one event down
- <F2> when pressed for over 2 seconds, scrolls quickly down
- <F3> allows you to specify the competitor whose times you want displayed
- <F4> allows you to specify the relative run
- <F5> prints the time event indicated by the symbol ◀ .

6. Rankings and other printouts

This menu contains the various printing options offered by REI2. Some printouts can be both consulted on the display and printed.

All print management is included in the menu M 1 C → **Rankings and other printouts** and the following instructions refer to this menu.

6.1. Print/Show ranking

This function offers a wide range of choice as regards the data to be taken into consideration for printing the ranking.

The following options are always available:

- <ESC> to quit this choice
- <ENT> to show the list on the display
- <ALT>+<ENT> to print the selected ranking
- <F3> Run, to set the run number to refer to
- <F4> Group, to select the group whose ranking is required (0 for all the athletes entered).

Each time the <F1> **Ranking** key is pressed, a different ranking type is proposed.

The functioning of the <F2> and <F5> keys changes according to the choice made with <F1>. The following table summarises the various combinations possible:

<F1> value	<F2> options	<F5> options	Notes
Finish times	Manche times	---	Ranking of race set
Intermediate times	LAP	Intermediate number	
Intermediate times	SPLIT manche	Intermediate number	

If you decide to consult the ranking on the display, you can scroll the whole list or search for a specific competitor number at a specific position in the ranking.

Options available:

- <ESC> returns to the choice of time limits
- <F1> scrolls one event back on the list
- <F1> when pressed for over 2 seconds, scrolls quickly back up the list
- <F2> scrolls one event down
- <F2> when pressed for over 2 seconds, scrolls quickly down
- <F3> allows you to specify the competitor whose position you want to find
- <F4> allows you to specify the position for which you want to find the competitor, for example, to look for the 15th in the ranking
- <F5> to return to the previous menu.

6.2. Other printouts

This function is not available in the current version of this software.

6.3. Printout and Visualization mode

This function allows you to set a few preferences concerning what you wish to print.

The options available are:

- **<F1> Data visualization** : each press alternates between **Complete** and **Selection**. If the choice **Selection** is activated, only the times considered for the ranking calculation are shown on the display. If the choice **Complete** is activated, also those times which are of no significance for the ranking displayed are presented
- **<F2> Print gap** : each press alternates between **Disabled** and **Enabled**. If enabled, the time lag from the first athlete in the rankings is printed
- **<F3> Sort same time** : Each press switches between **Start order** and **Start order reversed**. In the first case, that is, according to start order, if two or more competitors have the same time, the first to have started wins (e.g. Nordic ski). In the second case, the second to have started wins (e.g. Alpine ski). So the calculation is not based on the competitor number but on the start time. The competitor number is only considered if two or more competitors start at the same moment.
- **<F4> Send printout on serial:** each pressing of the key changes the serial port on which to send a copy of the printed data. The possible alternatives are **NOTHING**, **SERIAL A**, **SERIAL B**, **ALL**. The data are printed in the same format in which they are sent. Empty lines are not always sent.

(other...)

- **<F1> Take previous laps:** this function is suitable for relay races or races in which the competitors must run more than one lap. If enabled, also those athletes who have not completed the full number of laps appear in the rankings on printouts and displayboards together with the number of laps by which they are behind.
- **<F2> Max athlete in rank.:** makes it possible to set the maximum number of competitors who must appear in the ranking. To include all the competitors, set to **0**
- **<F3> Printout competitors name:** each press alternates between **Disabled** and **Enabled**. If enabled, the competitor's name is printed in the rankings
- **<F4> Printout competit. nations:** each press alternates between **Disabled** and **Enabled**. If enabled, the competitor's nation is printed in the rankings.

6.4. Print/Show climatic data

This function is for managing the Microgate climatic sensor, the light sensor and the wind gauge. The climatic sensor measures the temperature and humidity of the air and the snow temperature. The wind gauge takes the direction and speed of the wind in the area. The light sensor gives the intensity of light as a percentage. For information about the use of the sensors, the wind gauge and the relative consult the relative manual.

6.4.1. View current climatic data

This function continuously reads the climatic sensor and shows the data taken on the display. It also shows the data taken when the various competitors finish if activated with the function Print climatic data(p. 31)

Hh:mm:ss.d		
Current Air temp. = -10,2 C		← Current climatic data
Current Snow temp.= -13,5 C		
Current Air humid.= 35 %RU		

Store data	Air temp. =-11,5 C	← Climatic data measured at the moment the competitor finishes
Number 7	Snow temp =-13.7 C	
Run 1	Air humid.= 37 %RU	
↑ ↓	Print Rep:--:--: quit	Competitor number and run for which the data have been taken

Options available:

- <F1> ↑: to visualize the previous data acquisition
- <F2> ↓: to visualize the next data acquisition
- <F3> **Print**: to print the data on the display
- <F4> **Rep**: to enter the frequency, in hours, minutes and seconds, with which to read the sensor and the printout of the data
- <F5> **Quit** to return to previous menu

6.4.2. View current wind data

This function continuously reads the wind gauge and shows the data taken on the display. If the function Print climatic data. has been activated, it also shows the data taken when the various competitors finish

Hh:mm:ss.d		
Current air speed= 10,2m/s		← Wind gauge data taken for current moment
Current direction= 13,5°		
Current lux = 35 %		

Stored data	Air speed= 11,5m/s	← Wind gauge data taken when competitor finished.
Number 7	Direction= 13.7°	
Manche 1	Lux = 37 %	
↑ ↓	Print Rep:--:--: quit	Number of competitor and run for which data was taken.

Options available:

- <F1> ↑: display previous set of data
- <F2> ↓: display next set of data
- <F3> **Print**: print data on display
- <F4> **Rep**: enter in hours, minutes and seconds the frequency with which the sensor is to be read and the data taken printed.
- <F5> **Quit**: return to previous menu

6.4.3. Print climatic data

Pressing the key <F2> switches between **Yes** and **No**, activating or deactivating measurement and printing on the printed strip of the climatic data taken at the moment each competitor finishes.

7. Starts management

This function is not available in the current version of this software.

8. Synchronization

REI2 can be synchronized by means of the keyboard, the external line or via radio with the LinkGate system. If necessary, synchronization can be corrected by putting the internal clock forward or back.

8.1. Synchronization

Through this function, REI2's internal clock is synchronized. The operation is performed by entering the time of synchronization, confirming each field (hour, minutes,) with the <ENT> key and then the date.

Attention: to be able to carry out synchronization the start line must be 'at rest' when <F4> is pressed (open for line N/O, closed for line N/C). If the line is not 'at rest', the message '!!!ATTENTION !!!! START line unable to give synchronization impulse.....' will appear.

With:

- <F2> the entered data can be modified if a mistake has been made
- <F4> to confirm synchronization data. With the next start impulse, the internal clock starts
- <F5> returns you to the previous menu.

8.2. Modify synchronization value

In certain situations it may be necessary to change the synchronization of REI2 to align it with other devices which cannot be resynchronized. After establishing the gap in synchronization between the two devices (for example with a stop in parallel), enter the value as 'Time change' (paying attention to the alignment; for example, 3 hundredths should be entered as 3000 ten-thousandths). The date can also be changed. Each value should be confirmed with <ENT>.

The enabled function keys are:

- <F1> **Time** + to change the sign of variation; with each press it enables the increase or reduction of values
- <F3> **Correct** to change any incorrectly entered data
- <F4> **OK** to carry out correction of synchronization
- <F5> **menu** to quit the function.

8.3. Synchronization verify

Calling up this function makes REI2 ready to receive an impulse from a line (main or LinkPod) or the LinkGate system

The message **SYNCHRONIZATION VERIFY – Wait for impulse...** appears on the display. When REI2 receives an impulse, the channel the impulse comes from and the date and time when it was acquired are printed on the printed strip.

8.4. Signal

With this function a synchronization impulse for the synchronization of other devices can be generated. When the function is activated, a request is made for the time and date for generation of the impulse. Every value must be confirmed with <ENT>.

The signal is generated by switching pin 6 of the I/O digital port to level 0.

9. Disqualifications

This function is used to enter any disqualified athletes and to put previously disqualified athletes back into the race. When you enter the function, you are asked for the race number and the manche (trial) to which the disqualification refers. When you have entered the data requested, it is possible to see the competitor's current status by pressing <ENT>.

The enabled function keys are:

- <F1> **Modify**: Each time you press the key, the competitor passes from **Qualified** to **Disqualified** status
- <F3> **Other**: to enter the number and run of another competitor
- <F5> **menu**: to quit the function.

When the manche (trial) is retrieved, the lane occupied by the disqualified competitor appears indicated by the symbol §.

10. Download data to PC

When a competition is in progress or at its end the transmission of data to the electronic processors may be requested without the processor itself requesting this. The port to use and the transmission velocity can be specified with the function Serial ports setup (see section 12.3 on p.43).

There are two data transmission modes,; ‘Off-line’ and ‘On-line’.

The data which can be sent is:

- **Time events:** all the events recorded
- **T Totals:** total times
- **T Run:** the times of individual runs
- **T Lap:** intermediate times
- **NS,NF,DISQ:** all the competitors not in the competition such as non-starters, non-finishers and disqualified competitors (only off-line)
- **Skipped:** all skipped events
- **Speeds:** calculated speeds, both average and instant time.

10.1. Off-Line data transmission

With this function it is possible to select the data to be sent to the PC and to begin its transmission. The data indicated with **On** will be sent to the PC through the specified serial port. It is possible, if required, to specify the run and/or group of competitors whose data is to be sent (the value **0** indicates all).

The enabled function keys are:

- <F1> ↑: to move the cursor up
- <F2> ↓: to move the cursor down
- <F3> **Modify:** allows you to change the **Run** or **Group** number or to select (**On**) / deselect (**Off**) the data type, indicated by the arrow (→), to be transmitted
- <F5> to return to the previous menu.

During transmission the message ‘**Transmission.....in progress**’ appears on the display and for each type of data requested, the type and number of records transmitted.

10.2. On Line data output setup

This function allows you to specify the data to be sent to the processor at the instant in which REI2 stores them in its memory. Some of these, such as the start (in standard setting) are immediately stored and then transmitted. Others, like the stop, must be confirmed by the operator and are then sent only after the user has given confirmation.

The enabled function keys are:

- <F1> ↑: to move the cursor up
- <F2> ↓: to move the cursor down
- <F3> **Modify:** allows you to select (**On**) / deselect (**Off**) the data type, indicated by the arrow (→) to be transmitted
- <F5> to return to the previous menu.

	REI2 Swimming Program	Doc: R2U_N_1079_002_E Version: 1.07.9 Page 37 of 78
---	--------------------------	---

On-line data transmission can be activated and deactivated as you desire while a competition is in progress. You should keep in mind, however, that REI2 does not transmit events and values calculated on-line while transmission was deactivated.

10.3. Data output protocol

This allows you to choose which protocol to use for data transmission to PC. Each time a selection is made, one of the possibilities is activated, namely:

- **'Microgate'**: All the potentialities of the stopwatch are exploited
- **'Alge 4000'**: Data is transmitted using the same protocol as for Alge 4000. The choice of data which can be transmitted with this protocol (see chap. 10.1 Off-Line data transmission on p.36 and chap. 10.2 On Line data output setup on p.36) is limited to net times only.
- **'FinishLynx'**: used if the stopwatch is connected to a FinishLynx photofinish

For greater completeness and flexibility, we recommend that you use the Microgate protocol and that you use the Alge protocol only if there are problems of computing with the software used for data processing.

Serial velocity is automatically set to 2400 for both serial ports (see chap. 12.3 Serial ports setup on p. 43).

11. Upload data from PC

11.1. Upload of lists from PC

11.1.1. Upload of competitor lists from PC

This function allows you to upload the list of competitors generated by the Microgate Uploader ©, Microrun© or MicroLink©. When you have entered the function Upload data from PC, press key <F1> for **Upload of lists from PC** and <F1> again for **Upload competitor list from PC**. On the second line of the display the message '**Ready to upload**' appears and you have 20 seconds to start data transmission on the PC.

If no data is received in this period, the message '**Serial communication Time Out Press any key**' appears. Press a key to continue. Press <ENT> to return to the group management menu.

After upload has been activated it is possible to interrupt it before time out by pressing the <F2> key for **Break** and the <ENT> key again when the message '**Reception interrupted**' appears.

During correct upload, the data is rapidly listed on the screen. When upload is completed, the message '**End of reception. Press a key**' appears. Press <ENT> to return to the menu.

However, REI2 can receive the competitor list in background without the need to access this menu.

Detailed information about the data structure sent from PC to REI is given in chap. 25 REI2 – PC communication protocols on p.69.

For connection modes between REI2 and PC, consult the **User Manual**.

11.1.2. Upload groups structure from PC

This function is not available in the current version of this software.

11.1.3. Upload of start lists from PC

This function allows you to upload the start orders generated by the Microgate REI2 Uploader ©, Microrun © or MicroLink © programs. Press the key <F1> for **Upload data from PC**, key <F3> for **Upload start list from PC** and <F1> again for **Upload start list from PC**. On the second line of the display the message '**Ready to upload.....**' appears and you have 20 seconds to start data transmission on the PC.

If no data is received in this period, the message '**Serial communication Time Out Press any key**' appears. Press a key to continue. Press <ENT> to return to the group management menu.

After upload has been activated it is possible to interrupt it before time out by pressing the <F2> key for **Break** and the <ENT> key again when the message '**Reception interrupted**' appears.

During correct upload, the data is rapidly listed on the screen. When upload is completed, the message '**End of reception. Press a key**' appears. Press <ENT> to return to the menu.

However, REI2 can receive start orders in background without the need to access this menu.

Detailed information about the data structure sent from PC to REI is given in chap. 25 REI2 – PC communication protocols on p.69.

For connection modes between REI2 and PC, consult the **User Manual**.

11.2. *Print out lists*

Selection of this function allows you to print various lists.

The enabled function keys are:

- **<F1> Print competitors list** to print the list of those who have entered for the competition. On the printout the competitor number, nation and name are indicated
- **<F2> Print group structure**: This function is not available in the current version of this software
- **<F3> Print start list** to print the start list for races. It also prints the names of the competitors for the different lanes present
- **<F5> menu** to quit the function.

11.3. *Delete lists menu*

This function allows you to delete the various lists in REI2's memory.

11.3.1. Delete competitor name lists

This function allows you to delete the list of competitors' names. To confirm the decision to delete, press **<F4>** for **Yes**, otherwise annul deletion with **<F5>** for **No**. When confirmation of the decision to delete has been given, the message **'Competitors' names deletion done!** appears for a few moments on the penultimate line of the display.

11.3.2. Delete groups structure

This function is not available in the current version of this software.

11.3.3. Delete start lists

This function deletes the start list for the races.

12. REI2 Setup

The various configuration menus allow you to modify the numerous settings that affect the way REI2 functions. When you decide to delete the configuration at the start of a new race or select Modify basic configuration (see relative chap. 22 on p.65) and select the configuration most suitable for the timing session, all the parameters will be set to those values most suitable in the greatest number of cases.

12.1. Software setup

This menu contains the settings which guide the functioning of the program.

12.1.1. Print Time of Day

Pressing the <F2> key allows you to activate/disactivate the printing of time events when the various events (Start, Lap, Stop) take place. When printing is disactivated, only net times are printed. Each time you press the key, one of the two alternatives is activated (**Yes** time event printing activated, **No** printing disactivated).

12.1.2. Time accuracy

When you select this option, you are asked for the precision of the measurement to be used for the calculation of Lap and net time. Remember that all the time events are recorded with the maximum precision (1/25000 of a second), which is also used to make calculations, whatever precision is set, unless the time event truncation function is active.

The options available are:

- <F1>: Each time you press this key, one of the 5 alternatives (1", 1/10, 1/100, 1/1000 e 1/10000) is activated
- <F2> allows you to enter the figure (first not significant) starting from which you pass to the significant unit above (e.g. with precision at 1/100 setting 4 xx.2842 becomes xx.29 while xx.2839 becomes xx.28). If you set 0, truncation is always carried out
- <F3> activates the truncation of time events at the moment they are recorded. Each time you press the key, one of two alternatives is activated (**Yes** for truncation activated, **No** for no truncation). If truncation is activated, REI2 asks if truncation should be extended to all the time events of the race in progress and so also to those already recorded. With <F5> extension of truncation is not accepted, with <F4> irreversible truncation of all time events is accepted.

Time event truncation is useful in those races, such as the relay, in which, because of the various truncations, adding together the times of each relay runner can result in a total different from the total race time.



Truncation of chronological data is an irreversible operation. Once the intention to truncate the data present in the memory has been confirmed, it is no longer possible to retrieve the truncated part. Similarly, it is no longer possible to acquire the truncated part for all the new events recorded.

12.1.3. Manual threshold times

With this function some reference times are set for comparison with the main and reserve acquisitions.

The options available are:

- **<F1>** allows you to set the value in seconds of the maximum difference allowed between main and backup acquisitions. When this limit is exceeded, the symbol  appears blinking next to the relative lane
- **<F2>** allows you to enter the value in seconds after which manual acquisition is automatically entered if it has not been acquired.
- **<F3>** allows you to enter a value in seconds after which an electronic acquisition is automatically entered if it has not already been acquired.

12.1.4. Start threshold times

With this function, it is possible to specify the times, before or after the START impulse, in which to acquire any false starts. The values, expressed in thousandths of a second, can be specified independently for before and after the Start.

The following chart shows the meaning of the two limits:

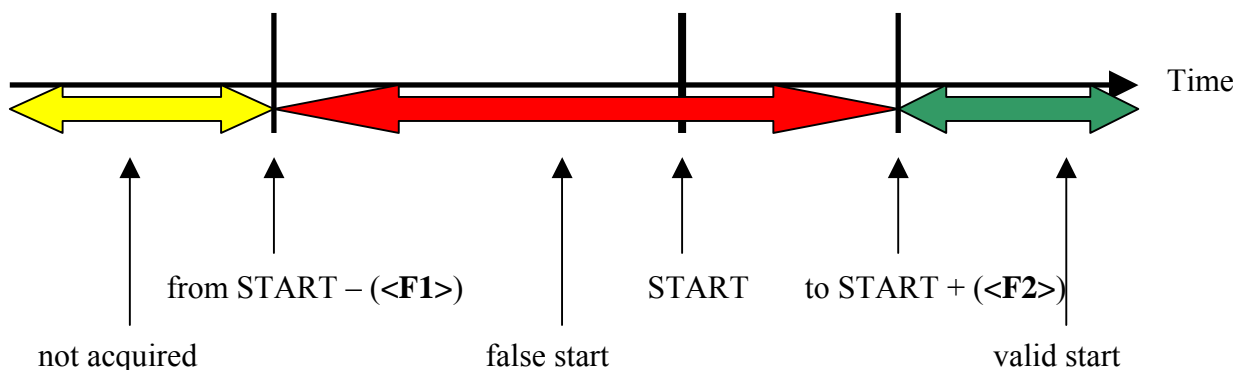

Figure 10 – False start evaluation.

Any impulses coming from the devices for the acquisition of false starts are ignored if acquired before the value **START from** specified (the competitor takes up position on the blocks). Those acquired from **START from** until **START to +** are considered to be for false starts and are indicated on the printed strip. Those acquired after the value **START to +** are ignored as they are considered to be for valid starts.

The options available are:

- <F1>** allows you to set the value in thousandths of a second of the acquisition before the Start
- <F2>** allows you to enter the value in thousandths of a second of the acquisition after the Start.



When the heat has started, REI2 considers the finish impulse (automatic) for every single lane as a reference for the acquisition of false starts. This allows it to acquire irregular changes in relay races with the same methodology.

This function is active only for the configuration **Automatic 2 ends + START**.

12.2. Hardware setup

This menu contains the settings which guide the functioning of the stopwatch.

12.2.1. LinkGate channel

Pressing key <F1> opens a submenu which shows the setting the dip-switches must have on the LinkGate®Encoder for the channel previously stored. Pressing <F2> **Modify** activates the cursor next to the channel number, from 0 to 127. Key in the number you intend to use. When you have entered the number and pressed <ENT>, the new setting the dip-switches must have on the LinkGate®Encoder is shown.

The first dip-switch does not affect channel selection and so is shown as **LONG** or **SHORT**.

Pressing <F3>**Length** modifies the position of the first dip-switch shown, alternately, as **LONG** or **SHORT**

The <F5> **menu** key returns you to the hardware configuration menu.

Remember that it is absolutely essential that the channel set on REI2 and on LinkGate Encoder should coincide. For further information see the User Manual.

12.2.2. Printer

This allows you to turn the printer off. Each time the <F2> key is pressed, one of the two alternatives **Off** or **On** is activated.

12.2.3. Keys Beep

This allows you to enable the emission of a beep each time a key is pressed. Each time the <F3> key is pressed, one of these two alternatives is activated: **Disabled**, no beep or **Enabled**, a short beep each time a key is pressed.

Beep emission always remains active and is not affected when the line keys are pressed.

12.2.4. Display contrast

This allows you to vary the contrast on the display to improve its legibility in conditions of bad light. The <F2> key allows you to reduce contrast while the <F4> key allows you to increase it. By pressing the two keys <F1> and <F4> for more than 2 seconds, you can regulate contrast more rapidly.

Remember that you can activate back-lighting of the display with the <Light> key. Be careful not to quit this function when contrast on the display is regulated in such a way that it is impossible to read it.

The <F5> key returns you to the hardware configuration menu.

12.2.5. Linkgate transmission length

Each time the <F1> key is pressed, one of the two alternatives **L** or **S** is activated. The setting chosen must correspond to the one made on the Linkgate Encoder (see user manual for further information). With transmission duration set to **S**, signals from the same EncRadio channel can be transmitted in rapid succession.

This configuration is particularly suitable, for example, in the acquisition of intermediate times which are close together in evaluation tests during training sessions.

Key <F5> returns you to the hardware configuration menu.

12.3. Serial ports setup

REI2 has two serials with protocol RS 232 for connection to data processors. The two serials, designated **Serial A** and **Serial B**, are individually configurable both for transmission velocity and the data presented. A few velocity combinations are, however, not available.

The configurable data are **Speed** for transmission velocity, **On-Line data** for sending data as soon as an event has occurred, **Off-Line data** for sending data in response to a request by the processor and **Tick** for the sending of running time for every pre-set period.

When you enter configuration, the following function keys are activated:

- <F1> ↑ allows you to scroll up the various configurable features
- <F2> ↓ allows you to scroll the list down
- <F3> ⇔ to pass from serial A to serial B
- <F4> **Modify** to change the setting indicated by ▶; each time you press, one of the values possible is activated
- <ALT>+<F2> **Tick delay** makes it possible to set the delay in ten thousandths of a second, in which form the tick is sent on the serial. Using a LinkGate system for finishes this is advisable at the minimum 200 to prevent the time displayed from running backwards, while for LinkPods 150ms is recommended.
- <F5> **menu** to return to the configuration menu.

The values which can be set are:

- **Speed** (in bps): 1200, 2400, 4800, 9600, 19200, 28800, 38400, 57600, 115200
- **On-Line data**: Yes for transmission activated, No for transmission not activated
- **Off-Line data**: Yes for transmission activated, No for transmission not activated
- **Radio In**: Yes to enable the serial for wireless reception of events and to modify the speed to 1200.
- **Tick**: Disab. For no transmission, 1s, 1/10 and 1/100.

The values set can be changed with the appropriate commands sent by the processor REI2. For details of transmission and reception protocol, consult 25 REI2 – PC communication protocols on p.69.



Not all the combinations of Serial A and Serial B velocity are compatible. REI2 indicates this by putting a line through the speed which cannot be set (e.g.: Ser. A: 1200 Ser. B ~~115200~~).

12.4. Printout Stopwatch setup

With this function, which can be obtained by pressing the <F4> key **Printout Stopwatch setup**, you can get a complete printout of the configuration set on REI2.

13. Displayboard Setup

With this menu, the type of displayboards connected to REI2 can be set and some of their operational modes specified.

13.1. Virtual Scoreboard

REI2 can directly manage up to 16 strings of Microgate μ Tab displayboards (each string is formed of a master displayboard and, if required, up to three slave displayboards) or μ Graph displayboards. This function allows you to select their type, number and the data to be presented on each of them.

13.1.1. Default Configuration

When you have entered function **<F1> Virtual scoreboard** and press **<F1> Default configuration** again, the guided configuration function for displayboards necessary for the display of the result obtained by each competitor is activated.

In practice the result obtained (position and time) and, possibly, the personal data (name and nationality) of every competitor are shown simultaneously on a series of displayboards, one per line. There are two main types of display - by position and by lane:

- **For rank:** The data for the competitor in first place appears on the first line, for the competitor in second place on the second line, and so on. Running time appears on the first line available, so firstly on the first line. When the first competitor finishes, running time passes to the second line, and so on.
- **For lane:** The data of the competitor in the first lane appears on the first line, for the competitor in the second lane on the second line, and so on. A displayboard (also with the address 0) is activated for the display of running time and all the times acquired.

The following table summarizes the various combinations obtainable by exploiting this function.

Choices	Addressing	Display
<F1> 4 Microtab		
<F1> Displayb. for lane	The displayboard address, from 1 to 10, coincides with the lane number	Lane, position, time athlete's name
<F2> Displayb. for rank	The displayboard address, from 1 to 10, coincides with the position	Position, lane, time athlete's name
<F2> 2 Microtab		
<F1> Displayb. for lane	The displayboard address, from 1 to 10, coincides with the lane number	Position, lane, time
<F2> Displayb. for rank	The displayboard address, from 1 to 10, coincides with the position	Position, lane, time
<F3> 2 Micrograph		

<F1> Middle char		
<F1> Displayb. for lane	Address 1 lanes 1 and 2, address 2 lanes 3 and 4 and so on until address 5 for lanes 9 and 10	Position, lane, time athlete's name
<F2> Displayb. for rank	Address 1 position 1 and 2, address 2 position 3 and 4 and so on until address 5 for positions 9 and 10	Position, lane, time athlete's name
<F1> Small character		
<F1> Displayb. for lane	Address 0 running time and data lane 1, address 1 lanes from 2 to 4, address 2 lanes from 5 to 7, address 3 lanes from 8 to 10	Position, lane, time athlete's name
<F2> Displayb. for rank	Address 1 positions from 1 to 3, address 2 positions from 4 to 6, address 3 positions from 7 to 9, address 4 position 10	Position, lane, time athlete's name
<F4> 1 Micrograph		
<F1> Single Disp. for single lane		
<F1> Displayb. for lane	The displayboard address, from 1 to 10, coincides with the lane number	Lane, position and time
<F2> Displayb. for rank	The displayboard address, from 1 to 10, coincides with the position	Position, lane, and time
<F2> Single displayb. for more lanes		
<F1> Middle char		
<F1> Displayb. for lane	Address 1 lanes from 1 to 2, address 2 lanes from 3 to 4, address 3 lanes from 5 to 6, address 4 lanes from 7 to 8, address 5 lanes from 9 to 10.	Position and race time
<F2> Displayb. for rank	Address 1 lanes from 1 to 2, address 2 lanes from 3 to 4, address 3 lanes from 5 to 6, address 4 lanes from 7 to 8, address 5 lanes from 9 to 10.	Lane and race time
<F1> Small char		
<F1> Displayb. for lane	Address 0 race time in 2/3 height; position 1, address 1 positions from 2 to 4, address 2 positions from 5 to 7, address 3 positions from 8 to 10.	Position and race time

<F2> Displayb. for rank	Address 1 positions from 1 to 3, address 2 positions from 4 to 6, address 3 positions from 7 to 9, address 4 position 10	
--------------------------------	---	--

By accessing the function 13.1.2 Free configurations (p.46) it is possible, if desired, to modify the configurations created with the current function. Accessing this function, however, cancels the previously entered settings.

The special displayboard types used in the guided configurations can also be accessed from free configuration, but it is not possible to change the combinations of addresses and the data displayed (e.g. the data for the first to arrive can be shown on μ TAB only at address 1).

In heats with more than one lap, the transit times of the different lanes or positions remain on the displayboards until the lane of the leader is rearmed, at which moment they are set to zero.

13.1.2. Free configurations

When you enter the configuration function with the key <F1> **Virtual scoreboard** and then select <F2> **Free configuration**, a list is proposed in which the configuration currently set is indicated.

In the 'Addr' column the address value to which the displayboard is to be set is indicated. Remember that the Address values of the displayboard must correspond to the value indicated in the first column.

In the 'DISP.TYPE' column, the type of displayboard chosen is shown; a series of ---- indicates an inactive line.

In the column 'DISP. NUM.' the number of displayboards set for that address is indicated.

In the column 'VISUALIZATION', the type of data which will be sent is shown with some abbreviations.

The active function keys are:

- <F1> \uparrow allows you to scroll the list up
- <F2> \downarrow allows you to scroll the list down
- <F3> **Modify** to change the displayboard setting on the Address indicated by \blacktriangleleft
- <F5> **menu** to return to the configuration menu.

When the **Modify** function has been selected, the configuration set for the line selected is shown.

The active function keys are:

- <F1> \uparrow allows you to scroll in one direction the list of configurations available which are compatible with the displayboard type and the number of elements selected
- <F2> \downarrow allows you to scroll in the other direction the list of configurations available
- <F3> **Disp. type** allows you to select the type of displayboard
- <F4> **N.Elem** allows you to select the number of displayboards on the line
- <F5> **Confirm** to return to the menu, accepting the configuration currently set
- <ESC> **Quit without confirming** to return to the menu without making modifications.

While you are choosing configuration, inside some rectangles you are shown how the data will appear on the displayboard. In the table below, some of the variations currently available are listed.

DB Type	Num.	Abbreviation	Description
Microtab	1	P Pos N Num	Letter P , position in max.2 figures, letter N and number in max. 3 figures
Microtab	1	Split time	Split time
Microtab	1	LAP time	LAP time
Microtab	1	Race T+Spl+Lap	Running race time. At the intermediate time split time followed by lap and once again running time
Microtab	1	Num RaceT	Competitor number and running time.
Microtab	1	L Lap N Num	Letter L , lap (intermediate) number, letter N and competitor number
Microtab	2	Pos Num RaceT	Position in max.3 figures and number in max. 5 figures, Running time or net time
Microtab	2	Athlete's Name	Athlete's surname and name
Microtab	2	Ppos Nnum RaceT	Letter P , position in max. 2 figures, letter N and number in max. 3 figures, Running time or net time
Microtab	2	Athlete's name Time	Athlete's name and running time
Microtab	4	1 Num RaceT Name	Number 1 , Number, net time and name of competitor in first position
Microtab	4	2 Num RaceT Num	As above but for second.
Microtab	4	3 Num RaceT Num	As above but for third
Micrograph	1	Pos Num Time	Medium-size characters: first line letter P , position in max. 3 figures, letter N , number in max. 5 figures; second line hours, minutes, seconds, tenths and hundredths.
Micrograph	1	Split lap time	Small characters: first line letter T and time, second line Split time and third line for Lap.
Micrograph	2	Graphic time	Time in hours, minutes, seconds and hundredths with full-size characters
Micrograph	2	1&2 N RaceT Name	Medium-size characters: on the first line number 1 , number, net time and name of competitor in first position; on the second line 2 and the same information for the second.

Micrograph	2	3&4 N RaceT Name	As above but for the third and fourth with the numbers 3 and 4 .
Micrograph	2	1&2&3 N RaceT N	Small characters: on the first line number 1 , number, net time and name of competitor in first position; on the second and third line numbers 2 and 3 and the same information for the second and third.
Micrograph	2	3&4&5 N RaceT N	As above but for the fourth, fifth and sixth with the numbers 4 , 5 and 6 .

The configuration chosen previously is activated as soon as you return to Displayboard configuration.

Let's look, for example, at how to set a configuration in which we have 4 μTAB displayboards (2 masters and 2 slaves) on which we want to display the number, position (preceded, respectively, by P and N) and the time on the first pair and the personal details of the competitor on the second pair. For instructions concerning the connection and setting up of the displayboards, consult the μTAB manual. (In the example displays, it is supposed that none of the displayboards have been previously configured).

After entering the function '**Virtual scoreboard**' – '**Free configuration**', press the <F1> key until the cursor ◀ is positioned alongside the 0 in the **LINE** column, then press

```

Hh:mm:ss.d
ADDR DISP.TYPE NUM.DISP VISUALIZATION
0◀ ----- -- -----
1 ----- -- -----
2 ----- -- -----
4 ----- -- -----

↑ ↓ Modify menu

```

<F3> for **Modify**

```

Hh:mm:ss.d
Display =None N.Elements= 0
-> [-----]

ESC=quit without confirming
↑ ↓ Disp.type E.Elem Conf.

```

<F3> again for **Disp.type** until the message **Display =Microtab** appears on the second line

```

Hh:mm:ss.d
Display =Microtab N.Elements 1
[34:56.78]

Race time
ESC=quit without confirming
↑ ↓ Disp.type E.Elem Conf.

```

Press <F4> for **N.Elem** and set the number of elements for line <2> and press <ENT>

```
Hh:mm:ss.d
Display =Microtab      N.Elements= 2

R12 N345 | 34:56.78

RRnk Nnum TRace
ESC=quit without confirming
↑ ↓ Disp.type E.Elem Conf.
```

Press the <F2> key until the message '**RRnk NNum TRace**' appears on the third line from the bottom

```
Hh:mm:ss.d
L ADDR DISP.TYPE NUM.DISP VISUALIZATION
0  Microtab      2      RRnk Nnum TRace
1  -----
2  -----
4  -----

↑ ↓ Modify menu
```

At this point, to set up the second line press <F2> to move next to N° 1, <F3> for **Modify**, <F3> again for **Disp.type** until the word **Microtab** appears on the second line, <F4> <2> <ENT> to set the two elements and <F2> until the words **Name Athlete** appear on the third from bottom line.

```
Hh:mm:ss.d
Display =Microtab N.Elements= 2

Name Surname

Name Athlete
ESC=quit without confirming
↑ ↓ Disp.type E.Elem Conf.
```

Press <5> to confirm the setting and to return to the configuration menu.

```
Hh:mm:ss.d
ADDR DISP.TYPE NUM.DISP VISUALIZATION
0  Microtab      2      Ppos Nnum TRace
1  Microtab      2      Name Athlete
2  -----
4  -----

↑ ↓ Modify menu
```

Your configuration is now ready and you can quit the function with <5> **Menu**.

13.2. Visualization pause

By pressing the <F2> key, it is possible, in the field with the indication **Stop**, to set the time the data of the finished competitor remains on the displayboard, and in the field with the indication **Lap**, the time the data of the competitor who has arrived at the intermediate stage remains. The times of display can be set from 1 to 60 seconds and confirmed with <ENT>. For the modes with which REI2 uses this data item see Displayboard management (chap. 4.8 on p.22).

This value must be set at a value which enables the competitor to read the displayboard, and avoids excessive queuing.

13.3. Serial speed of displayboard

With this function you can set REI2's velocity transmission to the Microgate μGRAPH displayboards. Remember that the velocity of the serial lines of the μGRAPH displayboards can be configured by the user, while that of the μTAB displayboards is fixed at 1200 (except on special versions).

Each time you activate the <F3> key, one of the possible options (1200, 2400, 4800, 9600, 19200, 28800, 38400, 57600) is activated.

Note: The velocity set on REI2 must coincide with the velocity set on the displayboard.

13.4. Spot program

Every time selection is made the activation command and deactivation command of the ‘Spot’ program are sent alternately to the displayboards. For further details, refer to the manuals for the Microgate Micrograph and Microtab displayboards.

13.5. Visualization nation

Every time selection is made the display of the competitor’s nationality is activated/deactivated. The function is relevant only if the nationality of the individual competitors has been uploaded onto REI2 . (See chap. Upload of competitor lists from PC on p.38.)

13.6. Configuration line 485

Every time selection is made communication on the serial port RS485 (as well as on port RS 232) is activated/deactivated. Refer to the **user manual** for further details.

13.7. Visualize time without points

Every time selection is made the emission of the time without the characters separating hours, minutes, seconds and fractions of a second or between seconds and fractions is activated/deactivated while continuing to follow the arrangements described in Time accuracy (chap. 12.1.2 p.40). If set to **No**, the display format is HH:MM:SS.DCMd, therefore with the separating characters ‘:’ and ‘.’. If set to **Yes**, the display format is HHMMSSDCMd.

13.8. Max num in RollRank

This function is enabled if displayboards with rolling rankings are chosen. The maximum number of competitors in the rankings can be set by entering a value different from zero.

13.9. Displayboard available

This function makes it possible to select the displayboard to be used from the various alternatives and to assign it to an address.

Hh:mm:ss.d Displ. Available ~E					
NUM	DISP.TYPE	ADDR	NUM	VISUALIZATION	
▶ 0	Microtab	--	1	Running Time	
1	Microtab	--	1	Rank Num	
2	Microtab	0	2	Rnk Num	T.Race
3	Microtab	--	2	Athlet Name	
↑		↓		Select	Menu

Example of possible visualizations

In the column ‘**NUM**’ the progressive configuration number is shown.

In the column ‘**DISP.TYPE**’ the displayboard type is shown.

In the column ‘**ADDR NUM**’ the Address value to be set on the displayboard is shown if the configuration has been selected, otherwise the symbol -- appears. Remember that the displayboard Address values must correspond to the value indicated in this column.

In the column ‘**NUM**’ the number of displayboards set for the selected combination is shown.

In the column 'VISUALIZATION' the type of data which will be sent is indicated with abbreviations.

The active function keys are as follows:

- <F1> ↑ to scroll the list up
- <F2> ↓ to scroll the list down
- <F3> **Select** sets the address for the configuration indicated by ▶ If an already used address is set, the configuration which previously had the same address is deselected.
- <F5> **menu** to return to the configuration menu.

13.10. Vis. delay dis./tick

This function makes it possible to set the delay with which the tick is sent to the serial in ten thousandths of a second. If a LinkGate system is used for finishes, the minimum of 200ms is advisable to prevent the time displayed from running backwards, while for LinkPods 150ms is recommended.

13.11. Displayb. Trans.length check

Setting this function activates control of the length of the data transmitted to the displayboard. If the displayboard viewing choices made involve too great a quantity of data for the serial speed set, REI2 will show a warning and give the minimum speed that can be set. In this case, if the function is active REI2 refuses to allow quitting of the menu until the speed of the displayboard has been modified.

13.12. Visualization pause RollRank

This function is enabled if displayboards with rolling rankings are chosen. The display pause between the displayboard scrolls can be set.

14. Input Lines Setup

REI2 can receive impulses through various channels. As well as the line keys, the main lines (Start Lap Aux and Stop), the LinkGate radio system (with or without built-in radio system) and the LinkPod system can be used. For operational and connection modes, consult the **User Manual**.

14.1. Physical/Logical Channel Assignment

This menu allows you to specify how REI2 must interpret the signals coming from the various input devices.

14.1.1. Main line and key Assignment

This function allows you to change the types of events acquired both on the main lines (Start, Lap, Aux and Stop) and on the corresponding line keys.

The enabled function keys are:

- **<F1> Logic Ch**: each time you press, one of the possible options for the channel indicated by the symbol ◀ is enabled. The options possible are **STOP**, **N.ASS** for unassigned, **START** and **LAP** and **MANUAL** to only print the time event and not store it afterwards. If the LAP option is selected, REI2 asks which intermediate stage/lap, from 0 to 249, it must be assigned to. If set at 0, REI2 will automatically move the lap number forward with each impulse
- **<F2> ↑↓** allows you to scroll the list of physical channels
- **<F3> ⇄** allows you to pass quickly from the line management column to the key management column
- **<F5> menu** to return to the configuration menu.



Although it is possible to change assignment of the physical channel of the keys, you are advised to do this only in cases of absolute necessity, taking great care after the modification has been made not to be misled by the characters on the keys.

14.1.2. Radio Channel Assignment

This function allows you to change the event types acquired through the LinkGate radio system. The radio channels are presented on two distinct screen displays, the first from 0 (start) to 7 and the second from 8 to 15 (Stop).

Initial assignment of radio channels is as follows:

- radio channel **0** as logical start channel
- radio channels from **1** to **9** as logical lap channel from 1 to 9 and then, radio channels from **A** to **D** as logical channels from 10 to 13
- radio channel **E** as generic lap (lap 0)
- radio channel **F** as logical stop channel.

The enabled function keys are:

- **<F1> Logic Ch**: each time you press, one of the possible options for the channel indicated by the symbol ◀ is enabled. The options possible are **STOP**, **N.ASS** for unassigned, **START** and **LAP** and **MANUAL** to only print the time event and not store it afterwards. If the LAP option

is selected, REI2 asks which intermediate stage/lap, from 0 to 249, it must be assigned to. If set at 0, REI2 will automatically move the lap number forward with each impulse.

- <F2> ↑↓ allows you to scroll the list of radio channels
- <F3> ⇔ allows you to pass quickly from one column to another
- <F4> **Others** allows you to pass from the management of the channels from 0 (radio start) to 7 to the management of the channels from 8 to 15 (radio Stop)
- <F5> **menu** to return to the configuration menu.

14.1.3. Linkpod Channel Assignment

As better described in the User Manual, the Microgate LinkPod © system consists of a series of from 1 to 10 ‘concentraters’ (pods) connected via cable. Depending on the type, each concentrater has up to 8 inputs making up a total of 80 lines.

This function allows you to assign the physical channel corresponding to each of the single pod inputs to a logical channel. Each pod is presented on its own screen display.

The enabled function keys are:

- <F1> **Logic Ch**: each time you press, one of the possible options for the channel indicated by the symbol ◀ is enabled. The options possible are **STOP**, **N.ASS** for unassigned, **START** and **LAP** and **MANUAL** to only print the time event and not store it afterwards. If the LAP option is selected, REI2 asks which intermediate stage/lap, from 0 to 240, it must be assigned to. If set at 0, REI2 will automatically move the lap number forward with each impulse
- <F2> ↑↓ allows you to scroll the list of inputs of each LinkPod
- <F3> ⇔ allows you to pass quickly from one column to another
- <F4> **N.Pod** allows you to pass from the management of one LinkPod to another by entering their respective numbers from 0, for the first, to 9
- <F5> **menu** to return to the configuration menu.

The number of LinkPods configured does not depend on the position of the cable but on the value set on each LinkPod.

14.2. Lines holdoff times

This allows you to modify the disactivation times of inputs after the acquisition of an event. Each line can be configured individually.

The enabled function keys are:

- <F1> ↑↓: allows you to scroll the list of the various configurable lines. The line selected is indicated by the character ◀ and the disactivation time expressed in milliseconds can be entered immediately
- <F2> ⇔ allows you to pass quickly from one column to another
- <F5> **Quit** to return to the configuration menu.

The last lap value (the one at the bottom on the right) can be configured for the channel number as well as for holdoff time.

The disactivation value can adopt any value you like between 0 and 60,000 milliseconds (1 minute).

If you try to change the value for a channel for which there is no corresponding physical channel, for a few seconds the message ‘**Logical.cha. not assigned to physic ch.!!!**’ appears.

14.3. Lines exclusion configuration

The <LCK> key situated over the <STA> key can be configured so as to offer the user the possibility of operating on one or more logical channels of his/her choice. (Vice versa, the <LCK> key over the <STO> key acts exclusively on the Stop logical channel). From this menu it is possible to select the lines on which the key is active. It is advisable to set the lines which are in fact controllable by the user.

The activation or disactivation of the <LCK> function on a line is shown by a filled in rectangle for lock enabled or an empty rectangle for lock disabled. A black blinking rectangle shows the position of the cursor.

The enabled function keys are:

- <F1> ←: allows you to move the cursor to the left on the various lines
- <F2> →: allows you to move the cursor to the right on the various lines
- <F3> **Modify**: pressing this enables or disables sensibility to the <LCK> key for the line on which the cursor is positioned
- <F4> **N.lap** allows you to set the lap number of the last rectangle on the right
- <F5> **Quit** to return to the configuration menu.

The <Rearm> key situated next to the <LCK> key operates on the same lines set for the <LCK> key.

14.4. Lines N/O N/C configuration

REI2 is designed to accept commands from devices which have contacts which are normally (at rest) either open or closed. From this menu it is possible to select the type of contact present on each of the main lines, both those connected through banana jack sockets or through standard din sockets.

The enabled function keys are:

- <F1> **Start**
- <F2> **Lap**
- <F3> **Stop**
- <F4> **Aux**
- <F5> **menu** to return to the configuration menu.

Each time the key associated with a line (from <F1> to <F4>) is pressed, one of the two options **Normally open** or **Normally closed** is enabled.

The Linkpod © inputs can be configured by acting directly on the device. For further information refer to the **User Manual**.

14.5. Noise filter principal lines

REI2 filters spurious events coming from external lines (e.g. start gates or switches).

The enabled function keys are:

- <F1> **Start**
- <F2> **Lap**
- <F3> **Stop**
- <F4> **Aux**
- <F5> **quit** to return to the configuration menu.

By default the noise filter is active on the Start line.

Every time the key assigned to a line is pressed (from <F1> to <F4>) one of the two options **Yes** – **No** is enabled.

15. Speed bases Setup

This function is not available in the current version of this software.

16. LinkGate data upload

This function is not available in the current version of this software.

17. LinkGate radio signal level

An essential condition for the correct use of the LinkGate system is a sufficiently high level of the quality of its radio signal. With this function, REI2 allows you to test its efficiency.

When you enter this function, the words '**RADIO SIGNAL QUALITY TEST**' appear, followed on the next line of the display by the words '**Ready to receive.....**'. At this point you can start a test transmission (for example, a start signal). After about 3 seconds from the start of transmission, during which the words '**Reception in progress.....**' is shown, the channel of the signal received and the quality of the signal expressed as a percentage are displayed. Naturally the higher the percentage, the higher the quality of reception.

Values above 40% are considered 'safe'.

If the channel set on the LinkGate Encoder does not coincide with the channel set on REI2 (see chap. LinkGate channel on p.42), the message '**RADIO XXXX – Channel xxx Signal= xxx% - Different channel received**' appears.

If the level of quality of the signal received is below 40%, one or more of the following steps can be taken:

- place both the transmitting and receiving radios (the radios connected to the Encoder) in an elevated upright position
- change the working frequency to avoid interference from the frequency used by other transmitters
- especially for the transmitting radio, use more efficient antennas such as $\frac{1}{4}$ or $\frac{5}{8}$ wave antennas instead of the normal 'charged' type.

The antennas supplied with the integrated LinkGate EncRadio and LinkGate DecRadio transmission system already have a high level of efficiency.

Note: the quality signal test should preferably be performed with the 'short-long' selector of the LinkGate Encoder device in the 'Long' (L) position. If the selector is on 'Short' (S), the maximum 'quality' value indicated by the test is about 25%.

For further details about the LinkGate system, consult the **User Manual**.

With the <F5> **menu** function key, you return to the previous menu.

18. Time calculator

REI2 has a sexagesimal calculator.

18.1. Normal

Key in the first time you wish to add or subtract (TA); then key in the second time (TB).

The enabled function keys are:

- **<F1> A+B**: adds TA to TB
- **<F2> A-B**: subtracts TB from TA
- **<F3> Modify** allows you to change the two set times
- **<F5> menu** to return to the previous menu.

The times are 'normalized' to 24 hours; for example, $2:00:00.000+23:00:00.000 = 1:00:00.000$ and not $25:00:00.000$.

Be careful when keying in thousandths, especially if the times to add or subtract are expressed with an accuracy of a tenth or a hundredth; for example, to enter the time 1:02.84 (one minute, two seconds, 84 hundredths), you must key in:

<0> <ENT> (hours)

<1> <ENT> (minutes)

<2> <ENT> (seconds)

<8><4><0><0> <ENT> (ten thousandths), and NOT **<8><4> <ENT>**.

18.2. Extended (day management)

Functioning is the same as for the normal calculator. In addition it offers you the possibility of entering a figure for the day, thus allowing calculations on values which cover a number of days.

19. Modem

In this menu it is possible to communicate with a modem connected to REI2.

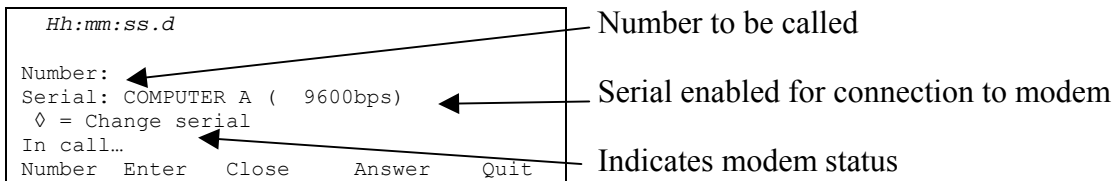

The active function keys are:

- **<F1> Number** allows you to enter the number to be called
- **<F2> Enter** to call the number entered
- **<F3> Close** to interrupt communication with the modem
- **<F4> Answer** to reply to the external call
- **<F5> Quit** to return to the configuration menu.

To call an external number just connect the modem to the enabled serial output, enter the number to be called by pressing **<F1>** and keying in the single numbers in succession. Then when **<F2> Enter** is pressed, the text **In call...** will appear. If the number called replies, the connection is automatically activated.

When there is an external call, the text **In answer...** will appear. Press **<F4>** to activate connection to the modem.

20. Recharge batteries

During normal functioning, the presence of a valid external source of power supply (with a socket as symbol) or low battery condition (with the symbol of a battery) is shown in the display to the right of the first line. From the moment the symbol appears, about 90 minutes of autonomy remain.

Recharging of REI2's internal batteries is managed entirely by the microprocessor. In this way it has been possible to implement a recharge control which guarantees maximum efficiency of the batteries at all times, at the same time prolonging their operational life.

When you enter this function, the current state of power supply is shown on the sixth line of the display as follows:

- **'Battery in use ...'** the internal batteries are being used
- **'Maintenance'** the stopwatch is supplied by the external power source and at the same time the efficiency of the batteries is maintained by a trickle charge but they are NOT recharged
- **'Discharging...'** the internal batteries are being completely discharged before being subsequently recharged
- **'Recharge'** recharge in progress; on the right, the time remaining before the end of recharge is shown
- **'Recharge stopped'** recharge has been temporarily interrupted because of insufficient voltage. It will resume automatically as soon as a sufficient level of voltage is restored.

To recharge the batteries, connect a continuous 12-20 volt power source to the appropriate power point.



To recharge the batteries or completely discharge them, REI2 must remain switched on. During recharge it is possible to carry out every kind of timing. The important thing is not to switch it off.

20.1. Discharge/recharge

When this function is selected, the internal batteries are first completely discharged and then recharged. This is the most correct procedure for keeping the internal batteries at maximum efficiency.

The duration of the discharge phase depends on how fully the batteries are charged and can last up to about 3 hours.

The duration of the subsequent recharge phase is 7 hours, at the end of which the message **'RECHARGE OK!'** appears.

20.2. Immediate recharge

If it is not possible to charge or recharge in the correct way because of lack of time or for any other reason, it is possible just to recharge. In this way recharge time is reduced but this procedure is not recommended as it reduces the efficiency of the batteries.

20.3. Break

With this function the discharge and recharge phases are interrupted. REI2 returns to maintenance status.

21. Race management

REI2 can memorize up to 8 different races and their relative configurations. It is possible to suspend a race at any moment, to manage a different one and then to retrieve the suspended race.

As soon as REI2 has finished checking synchronization and memory content it activates the race management menu.

At the end of timing, no operation is necessary to memorize a race. All the data is automatically recorded in the stopwatch's memory and retained also when the machine is switched off. For stored data retention times, consult the **User Manual**.

21.1. New race

Selecting this option allows you to start a new race. You are asked for the program to be used and when you have selected this, you are given the indication '**NEW RACE**' and the number assigned on the printout.

If all the eight races available have been stored, the message '**ATTENTION! – Race Memory Full – Delete one or more races – Press a key to continue**' appears and you must delete one of the stored races to be able to continue.

21.2. Delete/Recall stored race

This option allows you to retrieve or delete a previously stored race from the list of races proposed.

You have the following columns:

- **RACE**: In this column the progressive race number appears. The symbol * to the left of the number indicates the last active race, which is retrieved if Continue current race is selected
- **DATE**: the start date
- **START**: the start time
- **TYPE**: the type of program used for the race.

The positions which are free for memorization of a race are indicated by '---'.

The enabled function keys are:

- <F1> ↑: to scroll the race list up
- <F2> ↓: to scroll the list down
- <F3> to delete the race shown by the symbol ◀. You are requested to confirm that you wish to delete the race, <F4> to delete, <F5> to annul deletion. If you select an unused race number, the message '**Impossible to delete**' appears
- <F4> retrieves the race indicated by the symbol ◀ and allows you to resume timing it. If you select an unused race number, the message '**Race not available**' appears
- <F5> to return to the previous menu.

21.3. Continue current race

By selecting this option, you resume timing of the last race stored, and retain all its timings and configuration settings.

21.4. Clear all memory

Selecting this option allows you to delete all the data of all the stored races. On the display the message ******* ATTENTION ***** - All data and races will be deleted, in an irreversible way, Continue?** Press <F4> for **Yes** to delete all the stored races, press <F5> for **No** to annul the deletion operation.

22. Modify basic configuration

This function allows you to select which of the 4 configurations proposed is most suitable for the requirements of the event you intend to time. When you have selected the basic configuration, you can make whatever change you like to the configuration proposed.

The enabled function keys are:

- <F1> **Manual**
- <F2> **Automatic 1 end**
- <F3> **Automatic 2 ends**
- <F4> **Automatic 2 ends + START**

other

- <F1> **3 Manual 1 end**
- <F2> **3 Manual 2 ends**
- <F3> **Rowing**

For the values set by REI2, see Pre-set configurations on p.67.

23. Lines status

This function allows convenient management of the status lines connected to REI. To the right of their description, the main lines, Start, Lap, Stop and Aux have a little circle which indicates their status. For the Pods of the LinkPod system, the status of each of the 8 inputs of each Pod is indicated.

The indicators mean:

- Empty circle Line at rest
- Filled-in circle Line active
- Line (only Pod) Pod not present or not correctly connected or line not physically present on the Pod (Pod with fewer than 8 inputs).

24. Pre-set configurations

The table below summarizes the standard settings activated when one of them is selected:

	Manual	Automatic 1 end	Automatic 2 ends	Automatic 2 ends + start	3 manual 2 ends	Rowing
Precision	1/10	1/100	1/100	1/100	1/10	1/1000
POD (8 input) connections	Configurati on 1	Configurati on 2	Configurati on 3	Configurati on 4	Configurati on 4	Configurati on 1
Backup	N.A.	Available	Available	Available	Available	N.A.
Manual threshold times	0	5''	5''	5''	N.A.	0
Start threshold times	N.A.	N.A.	N.A.	-1000+125 ms	N.A.	N.A.
Lunghezze speciali	Yes	No	No	No	Yes	Yes

24.1. Pod configurations

REI2 uses the logical channel to determine the type of each event acquired and its relative lane. The logical channels are automatically associated with the various pod inputs according to the initial configuration selected.

The following table summarises the logical channels and the types of event associated.

Legend:

- M x:** Manual acquisition for lane x
- P x:** Automatic acquisition (touchpads) for lane x
- B x:** False start system for start in lane x
- MO x:** Manual acquisition opposite end
- PO x:** Automatic acquisition opposite end
- BO x:** False start system at opposite end.

POD n°	Line n°	Manual		Automatic 1 end		Automatic 2 ends		Automatic 2 ends + touchpads		3 manual at 2 ends	
		Type	Logical ch.	Type	Logical ch.	Type	Logical ch.	Type	Logical ch.	Type	Logical ch.
0	1	M 1	11	M 1	11	M 1	11	M 1	11	M 1.1	11
0	2	M 2	12	P 1	31	P 1	31	P 1	31	M 1.2	71
0	3	M 3	13	M 2	12	B 1	51	M 2	12	M 1.3	91
0	4	M 4	14	P 2	32			P 2	32		
0	5	M 5	15	M 3	13	M 2	12	M 3	13	M 2.1	12
0	6	M 6	16	P 3	33	P 2	32	P 3	33	M 2.2	72
0	7	M 7	17	M 4	14	B 2	52	M 4	14	M 2.3	92
0	8	M 8	18	P 4	34			P 4	34		

25. REI2 – PC communication protocols

25.1. From PC

To transmit information about athletes' names and nationalities and the composition of groups, and start lists, a file must be compiled for each of these functions. Within each line the various values are separated by the ASCII Tab (09h) character and the various lines by the character CR (13) (0Dh). The key words (highlighted in **bold**) should be sent exactly as they are written.

The data can only be sent to the Computer A output of the REI2 stopwatch. Transmission can also be made in background, so without the need to access the PC's data reception menu.

25.1.1. List of athletes' names and nationalities

The list of the athletes' names and nationalities specifies the assignment of a competitor number and a particular name. Each assignment is placed on a different line of the text, and the complete format is as follows:

\$STARTL	Start of list of names, must be written exactly as it appears here at the side
CR	Carriage Return (0Dh)
	The following information is repeated for each competitor entered:
comp. no.	Athlete's number (e.g. 1)
TAB	Tabulator (09h)
nat	Nation abbreviation of three characters (e.g. ITA)
TAB	Tabulator (09h)
Name	First name and surname (max 24 characters), only one space is allowed between first name and surname (e.g. Isolde Kostner), also compound names can be sent using _ to divide the name. E.g.: Marco_Andrea Di_Luca.
CR	Carriage Return (0Dh)
	End of repeated part of information about competitor
\$STOPL	End of list. Indicates to REI2 that the list of names is finished
CR	Carriage Return (0Dh)

→ **\$STARTL** CR ↑ comp. no. TAB nat TAB name CR | **\$STOPL** CR →

Example:

\$STARTL	Start of list of names, must be written exactly as it appears here at the side!
1 ITA Isolde Kostner	Assignment of competitor number 1 to the Italian athlete Isolde Kostner.
\$STOPL	End of list. Tells REI2 that the list of names is finished.

25.1.2. Start lists

The start list specifies the athletes' start order for each race.

The format of the list is:

\$STARTP Start of start list
 CR Carriage Return (0Dh)
 For each race to load, repeat the following part
 #Race Race number (**1..200**)
 , Comma (2Ch)
 # Heat Battery number (**1..199**)
 , Comma (2Ch)
 # Laps Number of laps (**1..99**)
 , Comma (2Ch)
 # Event Type of event (**Q** preliminary qualifications, **O** final stage qualifications
U quarter finals, **S** semifinals, **F** finals)
 , Comma (2Ch)
 # Sex Sex (**M** male, **F** female, **A** mixed)
 , Comma (2Ch)
 # Style Style (**L** crawl, **R** breaststroke, **D** backstroke, **F** butterfly, **E** dolphin, **M**
 mixed)
 , Comma (2Ch)
 # NumberLane1 Athlete's number (**1...29999**). **0** if absent
 , Comma (2Ch)
 # NumberLane2 Athlete's number (**1...29999**). **0** if absent
 , Comma (2Ch)
 # NumberLane3 Athlete's number (**1...29999**). **0** if absent
 , Comma (2Ch)
 # NumberLane4 Athlete's number (**1...29999**). **0** if absent
 , Comma (2Ch)
 # NumberLane5 Athlete's number (**1...29999**). **0** if absent
 , Comma (2Ch)
 # NumberLane6 Athlete's number (**1...29999**). **0** if absent
 , Comma (2Ch)
 # NumberLane7 Athlete's number (**1...29999**). **0** if absent
 , Comma (2Ch)
 # NumberLane8 Athlete's number (**1...29999**). **0** if absent
 , Comma (2Ch)
 # NumberLane9 Athlete's number (**1...29999**). **0** if absent
 , Comma (2Ch)
 # NumberLane10 Athlete's number (**1...29999**). **0** if absent
 , Comma (2Ch)
 CR Carriage Return (0Dh)
 End of repeated part of race
\$STOPP End of start list
 CR Carriage Return (0Dh)

→ \$STARTP CR #Race,#Heat,#Laps #Event,#Sex,#Style,#NumberLane1,#NumberLane2 ... ,#NumberLane10 CR \$STOPP CR→

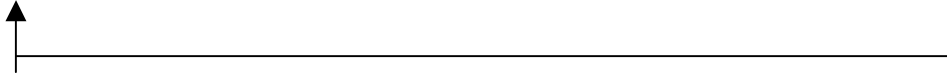

Example:

Race 10 10

Heat 2

Laps 2

Event Q

Sex M

Style L

NumberLane1 None

NumberLane2 13

NumberLane3 14

NumberLane4 15

NumberLane5 16

NumberLane6 17

NumberLane7 18

NumberLane8 222

NumberLane9 20

NumberLane10 None

\$STARTP

10,2,2,Q,M,L,0,13,14,15,16,17,18,222,20,0

\$STOPP

25.2. For PC

By using appropriate protocols, it is possible to ask REI2 for a series of items of information stored in its memory, such as net times and time events, running times and the status of competitors. The details and specifications of communication are given in **Appendix D** of the **User Manual**. No command sent through the connectors computers A and B can change the data present in the stopwatch apart from those specified, which, in any case, have to be confirmed on REI2.

For connection between REI2 and computer, use the ports 'Computer A' and 'Computer B'.

The number of the logical channel associated with the various events is calculated on the basis of the formula **End+Type+Lane** where type has the following values:

- 10 manual
- 30 automatic
- 50 false start sensors.

and end:

- 0 main finish end
- 100 other end

26. Menu structure

26.1. Initial menu

- A: New race
 - A: Single starts
 - B: Group starts
 - C: Simple stopwatch
 - D: Parallel Slalom
- Other
 - A: Show jumping
 - B: Swimming
 - C: PC-ONLINE
 - D: Dual Time
- B: Delete/Recall stored race
- C: Continue current race
- D: Clear all memory
- Other
 - A: Battery recharge
 - A: Discharge/recharge
 - B: Immediate recharge
 - C: Break
 - B: LinkGate radio signal level test
 - C: Line status (main lines and pod)
 - D: Autotuning battery

26.2. Race menu

(M 1)

- M 1.A: Timing 4 Timing 13
- M 1.B: Print Time of Day 5 Printing time of day 28
- M 1 C: Rankings and other printouts 6 Rankings and other printouts 29
 - M 1/3 A: Print/show ranking 6.1 Print/Show ranking 29
 - M 1/3 B: Other printouts (Disab.) 6.2 Other printouts 30
 - M 1/3 C: Printout and Visualization mode 6.3 Printout and Visualization mode 30
 - M 1/3/3 A: Data visualization : ... 6.3 Printout and Visualization mode 30
 - M 1/3/3 B: Print gap : ... 6.3 Printout and Visualization mode 30
 - M 1/3/3 C: Sort same time : ... 6.3 Printout and Visualization mode 30
 - M 1/3/3 D: Send printout on serial:... 6.3 Printout and Visualization mode 30
 - other
 - M 1/3/3b.A: Take previous laps 6.3 Printout and Visualization mode 30
 - M 1/3/3b.B: Max athlete in rank. (0=All)... 6.3 Printout and Visualization mode 30
 - M 1/3/3b C: Printout competitors name : ... 6.3 Printout and Visualization mode 30
 - M 1/3/3b D: Printout competit. nation : ... 6.3 Printout and Visualization mode 30
- M 1 D: Starts management (Disab.) 7 Starts management 32

Others (M 2)

M 2.A: Synchronization	8 Synchronization 33
M 2/1.A: Synchronization	8.1 Synchronization 33
M 2/1.B: Modify synchronization value	8.2 Modify synchronization value 33
M2 B: Disqualifications	9 Disqualifications 35
M 2.C: Download data to PC	10 Download data to PC 36
M 2/3 A: Off Line data Transmission	10.1 Off-Line data transmission 36
M 2/3 B: On Line data output setup	10.2 On Line data output setup 36
M 2/3 C: Serial ports setup	12.3 Serial ports setup 43
M 2/3 D: Data output Protocol : ...	10.3 Data output protocol 37
M 2 D: Upload data from PC	11 Upload data from PC 38
M 2/4.A: Upload data from PC	11.1 Upload of lists from PC 38
M 2/4/1 A: Upload competitor list from PC	11.1.1 Upload of competitor lists from PC 38
M 2/4/1 B: Upload groups structure from PC	11.1.2 Upload groups structure from PC 38
M 2/4/1 C: Upload start lists from PC	11.1.3 Upload of start lists from PC 38
M 2/4 B: Print out lists	11.2 Print out lists 39
M 2/4/2 A: Print competitor list	11.2 Print out lists 39
M 2/4/2 B: Print groups structure	11.2 Print out lists 39
M 2/4/2 C: Print start lists	11.2 Print out lists 39
M 2/4.C: Delete lists menu	11.3 Delete lists menu 39
M 2/4/3 A: Delete competitor name lists	11.3.1 Delete competitor name lists 39
M 2/4/3 B: Delete groups structure	11.3.2 Delete groups structure 39
M 2/4/3 C: Delete start lists	11.3.3 Delete start lists 39

Others (M 3)

M 3.A: REI2 Setup	12 REI2 Setup 40
M 3/1/: Software setup	12.1 Software setup 40
M 3/1/1 A: Print Time of Day	12.1.1 Print Time of Day 40
M 3/1/1.B: Time accuracy	12.1.2 Time accuracy 40
A: Time accuracy = ...	12.1.2 Time accuracy 40
B: Rounding (0 round off) = ...	12.1.2 Time accuracy 40
C: Round off chronological = ...	12.1.2 Time accuracy 40
M 3/1/1 C: Manual threshold time	12.1.3 Manual threshold times 41
M 3/1/1/3 A: Seconds difference warning	12.1.3 Manual threshold times 41
M 3/1/1/3 B: Manual input after seconds	12.1.3 Manual threshold times 41
M 3/1/1 D: Start threshold times	12.1.4 Start threshold times 41
M 3/1/1/4 A: False start from – (in ms)	12.1.4 Start threshold times 41
M 3/1/1/4 B: False start to + (in ms)	12.1.4 Start threshold times 41
M 3/1.B: Hardware setup	12.2 Hardware setup 42
M 3/1/2.A: LinkGate Channel : ...	12.2.1 LinkGate channel 42
M 3/1/2.B: Printer : ...	12.2.2 Printer 42
M 3/1/2.C: Keys Beep : ...	12.2.3 Keys Beep 42
M 3/1/2.D: Display contrast	12.2.4 Display contrast 42
other	

M 3/1/2b A: Linkgate transmission length : ...	12.2.5 Linkgate transmission	42
M 3/1.C: Serial ports setup	12.3 Serial ports setup	43
M 3/1.D: Print out Stopwatch setup	12.4 Printout Stopwatch setup	43
M 3.B: Displayboard Setup	13 Displayboard Setup	44
M 3/2.A: Virtual Scoreboard	13.1 Virtual Scoreboard	44
M 3/2/1 A: Default configuration	13.1.1 Default Configuration	44
M 3/2/1 B: Free configuration	13.1.2 Free configurations	46
M 3/2.B: Visu. pause : ...	13.2 Visualization pause	49
M 3/2 C: Serial speed displayboard = ...	13.3 Serial speed of displayboard	49
M 3/2 D: Spot program : ...	13.4 Spot program	50
Others		
M 3/3b A: Visualization nation : ...	13.5 Visualization nation	50
M 3/3b B: Configuration line 485 : ...	13.6 Configuration line 485	50
M 3/3b C: Visualize time without points : ...	13.7 Visualize time without	50
other		
M 3/2c A: Displayb. trans.length check	13.11 Displayb. Trans.length check	51
M 3/2c B: Displayboard available	13.9 Displayboard available	50
M 3/2c C: Rit. Visual. tab./tick:	13.10 Vis. delay dis./tick	51
Other		
M 3/2d A: Max num in rollrank:...	13.8 Max num in RollRank	50
M 3/2d B: Pausa visualizzaz. class. rot:...	13.12 Visualization pause RollRank	51
M 3 C: Input Lines Setup	14 Input Lines Setup	52
M 3/3 A: Physical/Logical Channel Assignment	14.1 Physical/Logical Channel Assignment	52
M 3/3/1 A: Main lines and Keys assignment	14.1.1 Main line and key Assignment	52
M 3/3/1 B: Radio Channel Assignment	14.1.2 Radio Channel Assignment	52
M 3/3/1 C: LinkPod Channel Assignment	14.1.3 Linkpod Channel Assignment	53
M 3/3.B: Lines holdoff times	14.2 Lines holdoff times	53
M 3/3.C: Lines exclusion configuration	14.3 Lines exclusion configuration	54
M 3/3.D: Lines N/O N/C configuration	14.4 Lines N/O N/C configuration	54
Other		
M 3/3b.A: Noise filter principal	14.5 Noise filter principal lines	54
M 3 D: Speed bases Setup (Disab.)	15 Speed bases Setup	56
Others (M 4)		
M 3 A: LinkGate data upload (Disab.)	16 LinkGate data upload	57
M 3.B: LinkGate radio signal level	17 LinkGate radio signal level	58
M 3.C: Time calculator	18 Time calculator	59
M 3/3.A: Normal	18.1 Normal	59
M 3/3.B: Extended (days management)	18.2 Extended (day management)	59
M 3.D: Recharge batteries	20 Recharge batteries	61
M 3/4.A: Discharge/Recharge	20.1 Discharge/recharge	61
M 3/4.B: Immediate recharge	20.2 Immediate recharge	61
M 3/4.C: Break	20.3 Break	62

Other (M 5)

M 5.A: Race management-→ return above

A: New race

B: Delete/recall stored race

C: Continue current race

D: Clear all memory

21 Race management 63

21.1 New race 63

21.2 Delete/Recall stored race 63

21.3 Continue current race 63

21.4 Clear all memory 64

M 4.B: Modify basic configuration

22 Modify basic configuration 65

M 4.C: Lines status

23 Lines status 66

M 4.D: Beeper

27. Editing history

The following table summarises the main changes made to this document.

Program version	Chapter	Page	Editing description
1.03			The first version of this manual refers to 1.03
1.07.9			General edit for version 1.07.9

	REI2 Swimming Program	Doc: R2U_N_1079_002_E Version: 1.07.9 Page 78 of 78
---	--------------------------	---

Copyright

Copyright © 1999, 2005 by Microgate s.r.l.
All rights reserved

No part of this document or of any of the individual manuals may be copied or reproduced without previously making a written application to Microgate s.r.l. for authorisation.

All the marks or names of products mentioned in this document or in the individual manuals are or may be registered marks belonging to the individual firms.

Microgate, REI2, REI, RaceTime, MicroTab, μ Tab, MicroGraph, μ Graph, MicroBeep, μ Beep, Uploder, Microrun, MicroLink, μ Flasher, LinkPod, LinkGate, LinkGate encoder, LinkGate decoder, EncRadio, DecRadio, Polifemo, MicroSem, μ Sem, are registered marks of Microgate s.r.l. or of licensed users.

Microgate s.r.l. reserves the right to modify the products described in this document and/or in the relative manuals without notice.

Collaborators in the creation of REI2 and the preparation of the relative manuals are:

Ing. Roberto Biasi,
Dr. Vinicio Biasi
Ing. Federico Gori
Ing. Alessandro Miorelli
Giuliano Minestrina
Daniele Veronese

The software and manuals are available in the following languages: Italian, English, German and French.

Microgate S.r.L
39100 Bolzano - Bozen
Via Stradivari, 4 Stradivaristr.
ITALY

Tel. +39 471 501532 - Fax +39 471 501524
e-mail info@microgate.it

