

Show Jumping Program

Summary

| | | |
|----------|---|-----------|
| 1 | CONVENTIONS | 7 |
| 2 | STARTING | 8 |
| 2.1 | Introduction | 8 |
| 2.2 | Switching on and choosing the program | 8 |
| 2.3 | Timing | 10 |
| 2.3.1 | First competitor | 10 |
| 2.3.1.1 | Start of countdown | 10 |
| 2.3.2 | Start of race | 11 |
| 2.3.2.1 | Intermediate | 11 |
| 2.3.2.2 | Finish | 11 |
| 2.3.2.3 | Confirm | 12 |
| 2.3.3 | Another competitor | 12 |
| 2.3.3.1 | Start of countdown | 12 |
| 2.3.3.2 | Suspension of countdown | 12 |
| 2.3.3.3 | Start of race | 12 |
| 2.3.3.4 | Penalties | 12 |
| 2.3.3.5 | Time correction | 13 |
| 2.3.3.6 | Penalty for refusal | 13 |
| 2.3.3.7 | Time count suspension | 14 |
| 2.3.3.8 | Finish and confirm | 14 |
| 2.3.4 | Quitting timing | 15 |
| 2.4 | Consecutive barrage | 15 |
| 2.4.1 | Choosing configuration | 15 |
| 2.4.2 | Consecutive barrage: first phase | 16 |
| 2.4.3 | Consecutive barrage: between first and second phase | 16 |
| 2.4.4 | Consecutive barrage: second phase | 17 |
| 2.4.5 | Consecutive barrage: elimination after first phase | 17 |
| 2.5 | End of race operations | 18 |
| 2.5.1 | Eliminations | 18 |
| 2.5.2 | Printing of ranking | 19 |
| 2.5.3 | End of session | 19 |
| 3 | PROGRAM CHARACTERISTICS | 20 |
| 4 | TIMING | 21 |
| 4.1 | Functional context | 21 |
| 4.2 | Starting a session | 23 |
| 4.3 | Single phase competition | 23 |
| 4.3.1 | Number currently racing | 23 |
| 4.3.1.1 | Change of race number | 23 |
| 4.3.2 | Initial confirmation of competitor | 24 |
| 4.3.3 | Start of countdown | 24 |
| 4.3.4 | Count suspension | 25 |
| 4.3.5 | Start of race | 25 |
| 4.3.6 | Points penalization | 26 |
| 4.3.7 | Penalization as time correction | 26 |
| 4.3.8 | Elimination | 27 |
| 4.3.9 | Time about to run out | 27 |
| 4.3.10 | Penalization for exceeding maximum time | 27 |

| | | |
|----------|---|-----------|
| 4.3.11 | Automatic elimination..... | 27 |
| 4.3.12 | Intermediate event..... | 27 |
| 4.3.13 | End of race..... | 28 |
| 4.3.14 | Confirmation of results..... | 28 |
| 4.3.15 | Ranking activation..... | 28 |
| 4.3.16 | Annul race..... | 28 |
| 4.4 | 2 phase progressive time competition..... | 28 |
| 4.4.1 | End of first phase..... | 29 |
| 4.5 | 2 phase separate time competition..... | 29 |
| 4.6 | Consecutive barrage competition..... | 30 |
| 4.7 | Functions..... | 30 |
| 4.7.1 | Annulment..... | 30 |
| 4.7.2 | Event annulment..... | 30 |
| 4.7.3 | Race annulment..... | 30 |
| 4.7.4 | Memo..... | 30 |
| 4.7.4.1 | Correction of time event..... | 31 |
| 4.7.5 | Run in progress..... | 31 |
| 4.7.6 | Forerunner mode..... | 31 |
| 4.7.7 | Race setup..... | 32 |
| 4.7.8 | Phase 1 correction..... | 32 |
| 4.7.9 | Start of second countdown..... | 32 |
| 4.8 | Displayboard management..... | 32 |
| 4.8.1 | Normal functioning..... | 33 |
| 4.8.2 | Disabling of displayboard..... | 33 |
| 4.9 | Lock keys..... | 33 |
| 4.9.1 | Discarded events management..... | 33 |
| 4.10 | Holdoff time disactivation keys..... | 34 |
| 4.11 | Quitting timing..... | 34 |
| 4.12 | Printout of time events..... | 34 |
| 4.12.1 | Printout of events..... | 35 |
| 4.12.2 | Printing of results..... | 37 |
| 5 | GROUP MANAGEMENT..... | 38 |
| 5.1 | Input/Modify groups..... | 38 |
| 5.2 | Print groups structure..... | 39 |
| 5.3 | Clear groups structure..... | 39 |
| 5.4 | Groups structure:..... | 39 |
| 5.5 | Uploading group structure from PC..... | 40 |
| 6 | RANKINGS AND OTHER PRINTOUTS..... | 41 |
| 6.1 | Print/Show ranking..... | 41 |
| 6.2 | Other printouts..... | 42 |
| 6.2.1 | Time of day..... | 42 |
| 6.2.2 | Started in run..... | 43 |
| 6.2.3 | Eliminated Printout..... | 43 |
| 6.3 | Printout and visualization mode..... | 43 |
| 7 | DEPARTURE MANAGER..... | 44 |
| 7.1 | Input start list..... | 44 |
| 7.2 | Start order calculation..... | 45 |
| 7.3 | Print start lists..... | 48 |

| | | |
|-----------|--|-----------|
| 8 | SYNCHRONIZATION | 49 |
| 8.1 | Synchronization | 49 |
| 8.2 | Editing synchronization value..... | 49 |
| 8.3 | Synchronization verify..... | 49 |
| 8.4 | Signal | 49 |
| 9 | ELIMINATIONS..... | 51 |
| 10 | DOWNLOAD DATA TO TO PC | 52 |
| 10.1 | Off-Line data transmission..... | 52 |
| 10.2 | On Line data output setup | 52 |
| 10.3 | Data output protocol..... | 53 |
| 11 | UPLOAD DATA FROM PC..... | 54 |
| 11.1 | Upload data from PC..... | 54 |
| 11.1.1 | Upload of competitor lists from PC | 54 |
| 11.1.2 | Upload groups structure from PC..... | 54 |
| 11.1.3 | Upload start lists from PC | 54 |
| 11.1.4 | Printouts lists | 55 |
| 11.1.5 | Delete lists menu | 55 |
| 11.2 | Printout lists | 55 |
| 11.3 | Delete lists menu..... | 55 |
| 11.3.1 | Delete competitor name lists | 55 |
| 11.3.2 | Delete groups structure..... | 56 |
| 11.3.3 | Delete start lists | 56 |
| 12 | REI2 SETUP | 57 |
| 12.1 | Software setup..... | 57 |
| 12.1.1 | Phases | 57 |
| 12.1.2 | Penalty settings..... | 57 |
| 12.1.3 | Table Ph1/sing..... | 57 |
| 12.1.4 | Table Phase 2..... | 58 |
| 12.1.5 | Maximum time penalty - phase1/single phase | 58 |
| 12.1.6 | Maximum time penalty - phase 2 | 58 |
| 12.1.7 | Add previous runs | 58 |
| 12.1.8 | Take delay after countdown | 58 |
| 12.1.9 | Ranking based on | 58 |
| 12.1.10 | Phase 1-phase 2 pause | 59 |
| 12.1.11 | Finish signals..... | 59 |
| 12.1.12 | Start time | 59 |
| 12.1.13 | Maximum time value..... | 59 |
| 12.1.14 | Time limit value | 60 |
| 12.1.15 | Delete after first phase: (2,S,C)..... | 60 |
| 12.1.16 | Phase 2 start time (2,S,C)..... | 60 |
| 12.1.17 | Phase 2 maximum time (2,S,C)..... | 60 |
| 12.1.18 | Phase 2 time limit (2,S,C) | 60 |
| 12.1.19 | Visualize countdown on displayboard | 60 |
| 12.1.20 | Print Time of day..... | 60 |
| 12.1.21 | Sound counter..... | 61 |
| 12.1.22 | Auto lines block after every event..... | 61 |
| 12.1.23 | Take point for 2 nd phase | 61 |
| 12.1.24 | Subtract penalty if T>Tmax | 61 |

| | | |
|-----------|--|-----------|
| 12.1.25 | Consider 0 points as 1st..... | 61 |
| 12.1.26 | Time accuracy | 62 |
| 12.1.27 | Time display mode | 62 |
| 12.1.28 | Start without countdown | 62 |
| 12.1.29 | Point accuracy | 63 |
| 12.1.30 | Add on displayb. T.C. at the end..... | 63 |
| 12.2 | Hardware setup | 63 |
| 12.2.1 | LinkGate channel | 63 |
| 12.2.2 | Printer on | 63 |
| 12.2.3 | Keys beep | 63 |
| 12.2.4 | Display contrast..... | 64 |
| 12.2.5 | LinkGate transmission length..... | 64 |
| 12.3 | Serial ports setup..... | 64 |
| 12.4 | Printout Stopwatch setup | 65 |
| 13 | DISPLAYBOARDS SETUP | 66 |
| 13.1 | Virtual scoreboard..... | 66 |
| 13.2 | Visu. pause..... | 69 |
| 13.3 | Serial speed displayboards..... | 69 |
| 13.4 | Spot program..... | 69 |
| 13.5 | Visualization nation | 69 |
| 13.6 | Configuration line 485 | 70 |
| 13.7 | Visualize time without point..... | 70 |
| 13.8 | Visualize penalty on displayboard..... | 70 |
| 13.9 | Max num in RollRank..... | 70 |
| 13.10 | Displayboard available..... | 70 |
| 13.11 | Vis. delay dis./tick..... | 71 |
| 13.12 | Displayb. Trans.length check..... | 71 |
| 13.13 | Visualization pause RollRank..... | 71 |
| 14 | INPUT LINES SETUP | 72 |
| 14.1 | Physical/logical Channel assignment..... | 72 |
| 14.1.1 | Main lines and Keys assignment..... | 72 |
| 14.1.2 | Radio Channel assignment..... | 72 |
| 14.1.3 | Linkpod Channel assignment..... | 73 |
| 14.2 | Lines holdoff times | 73 |
| 14.3 | Lines exclusion configuration..... | 74 |
| 14.4 | Lines N/O N/C configuration..... | 74 |
| 14.5 | Noise filter principal lines..... | 74 |
| 15 | SPEED BASES SETUP | 76 |
| 16 | LINKGATE DATA UPLOAD..... | 77 |
| 17 | LINKGATE RADIO SIGNAL LEVEL | 79 |
| 18 | TIME CALCULATOR..... | 80 |
| 18.1 | Normal | 80 |
| 18.2 | Extended (day management)..... | 80 |
| 19 | SET MODEM..... | 81 |
| 20 | RECHARGE BATTERIES..... | 82 |
| 20.1 | Discharge/recharge..... | 82 |
| 20.2 | Immediate recharge..... | 82 |

| | | |
|-----------|---|------------|
| 20.3 | Break | 83 |
| 21 | RACE MANAGEMENT | 84 |
| 21.1 | New race | 84 |
| 21.2 | Delete/Recall stored race | 84 |
| 21.3 | Continue current race | 84 |
| 21.4 | Clear all memory | 85 |
| 22 | MODIFY BASIC CONFIGURATION | 86 |
| 23 | LINE STATUS | 87 |
| 24 | PRE-SET CONFIGURATIONS | 88 |
| 25 | REI2 – PC COMMUNICATION PROTOCOLS..... | 89 |
| 25.1 | From PC | 89 |
| 25.1.1 | List of athletes’ names and nationalities | 89 |
| 25.1.2 | List of groups and their composition | 90 |
| 25.1.3 | Start Lists..... | 91 |
| 25.2 | For PC | 92 |
| 26 | MENU STRUCTURE..... | 93 |
| 26.1 | Initial menu | 93 |
| 26.2 | Race menu..... | 93 |
| 27 | EDITING HISTORY | 98 |
| 28 | COURSE TYPES | 100 |

Figure Index

| | | |
|-----------|--|-----|
| Figure 1 | – Competitor number request | 10 |
| Figure 2 | – Race in progress..... | 11 |
| Figure 3 | – Finished | 11 |
| Figure 4 | – Insertion of penalty in points | 13 |
| Figure 5 | – Time penalty insertion | 13 |
| Figure 6 | –Maximum time exceeded..... | 14 |
| Figure 7 | – End of race..... | 15 |
| Figure 8 | – Consecutive barrage: competitor number request | 16 |
| Figure 9 | – Consecutive barrage: between first and second phase..... | 17 |
| Figure 10 | – printed strip: events | 35 |
| Figure 11 | – printed strip: indications | 36 |
| Figure 12 | – printed strip with results | 37 |
| Figure 13 | – Configuration examples..... | 102 |

1 Conventions

In this manual the keys to be pressed are shown inside angled brackets. For example, press <**F1**> means the yellow key marked F1, while the options proposed by REI2 are indicated in bold type.

A time which is shown in *italics* on the display indicates that this time is running on the stopwatch.

An underlined figure indicates that the blinking cursor is in that position and the stopwatch is waiting for input.

2 Starting

2.1 Introduction

The best way to learn to use Microgate's REI2 stopwatch is to begin trying. Bear in mind that there is no sequence of keys which can damage your stopwatch. However, make sure you read the 'user manual' carefully before connecting any accessories.

This first chapter will guide you step by step through the management of a short competition using the preset configuration data.

During this first time of use we will simulate the various STOP and START impulses using the line keys. REI2 behaves in a similar way whether the impulse comes from the keyboard or from an external line.

We assume that no displayboard is connected.

2.2 Switching on and choosing the program

We start, of course, by switching on the stopwatch with the relative switch. For a moment the message ---SYSTEM BOOTING --- appears on the screen, and then some words of presentation and the version of the software installed.

If REI2's internal clock has not been synchronized or has in one way or another lost synchronization, you are informed of this (**The system has lost synchronization**) and two options are proposed, <F1> **Synchronize** or <F2> **Do not synchronize**. A choice must be made to be able to continue. You are also informed if the data in the memory is no longer valid (**ATTENTION MEMORY CORRUPTED = Press ENTER to continue**). Refer to the **User Manual** chap. **First switching on** for the relative instructions.

The information about the software version is also shown on the printout. When this phase is over, the first menu appears.

Hh:mm:ss.d

A:New race
 B:Delete/Recall stored race
 C:Continue current race
 D:Clear all memory

A B C D other

Let's select the **New race** option with <F1>. On the printout the choice we have just made will be shown, that is, NEW RACE, and REI2 asks us what type of race we are going to time.

Hh:mm:ss.d

Select the program:
 A:Single starts
 B:Group starts
 C:Simple Stopwatch
 D:Parallel Slalom

A B C D other

By pressing <F5> we pass to the second program choice screen display

Hh:mm:ss.d

Select the program:
 A:Show jumping
 B:Swimming
 C:PC-ONLINE
 D:Dual Time

A B C D other

And we press <F1> for **Show Jumping**.

Hh:mm:ss.d

A:Delete previous configuration
 B:Keep configuration of last competition

If the last race when REI2 was switched off was **Show Jumping**, we are given the options of keeping or deleting the previous configuration.

For the third time we select <F1> for **Delete previous configuration** and confirm our intention to delete the configuration with <F4>.

Hh:mm:ss.d

M 1

A:Timing
 B:Input/Printout groups
 C:Ranking and other printouts
 D:Departure manager

A B C D other

We are once more shown the choice made on the printed strip. Now we are ready to start the **Timing** session by pressing <F1> again.

From this moment on, the REI2 display no longer operates in 'text' mode but switches to 'graphic' mode.

Let's pause for a moment to analyse in

Figure 1 what now appears on the display.

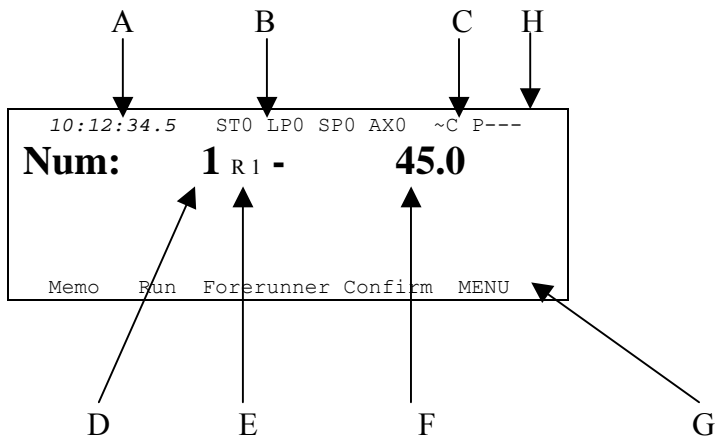

Figure 1 – Competitor number request

The positions indicated above are as follows:

- Running time of day
- Status of lines
- Power status
- Competitor number
- Run number of competitor at the start
- Initial countdown
- Other options that can be activated by pressing the <ALT> key and the function keys
- Provisional position in ranking

2.3 Timing

The preset configuration is for Single phase with a countdown time (T_{start}) of 45 seconds, a maximum time (T_{max}) of 60 seconds, a time limit (T_{lim}) of 120 seconds, a penalty for exceeding the time limit ($Pen.T > T_{max}$) of 1 point for every 4 seconds begun (FISE Table A), sound counter (**yes**) and automatic line block after each event (**no**).

2.3.1 First competitor

The first competitor to start is number 1. Let's simulate a race in which this first competitor does not incur any jumping or time penalties.

The number at the start must be confirmed by pressing the key <F4> **Confirm**. The next LAP impulse will start countdown.

2.3.1.1 Start of countdown

The signal has been given for the competitor in the arena to begin (ringing of bell). We press the key <LAP> to start countdown. The number of the competitor and of the run in progress are shown on the printout.

2.3.2 Start of race

After waiting about 20 seconds, we simulate the crossing of the start line by pressing the key <STA>. The countdown value at the moment of the start is printed on the printed strip. The appearance of the display changes as in Figure 2.

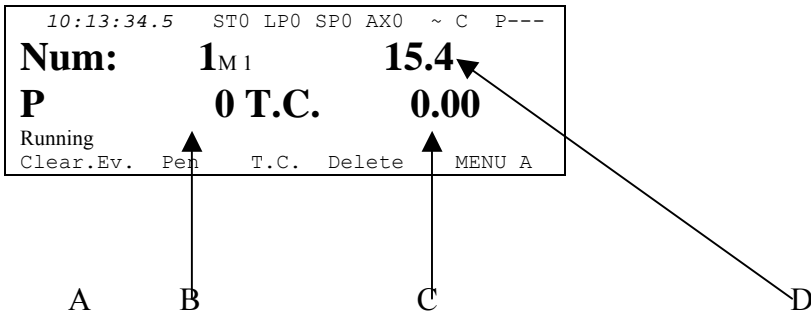

Figure 2 – Race in progress

- a) The competitor's 'status'
- b) Penalty points assigned
- c) Penalties as time correction
- d) Running time of competitor N° 1

2.3.2.1 Intermediate

To simulate the crossing of the intermediate line we press the <AUX> key. The intermediate time is printed on the printed strip and continues to blink on the display for about 6 seconds.

2.3.2.2 Finish

The competitor crosses the finishing line within the preset time limit (60 seconds) so when the running time is about 50 seconds we press the key <STO>.

The display changes as in Figure 3

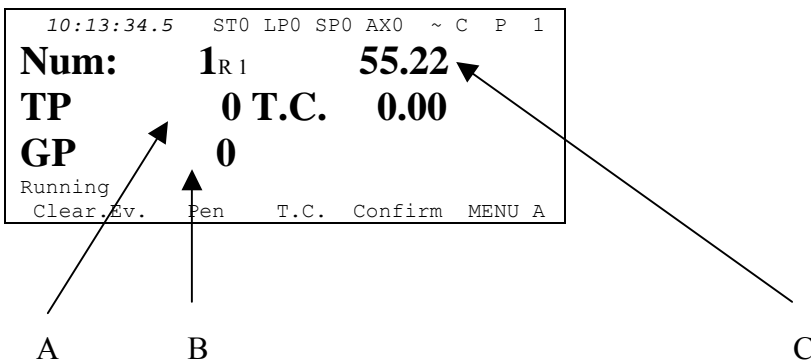

Figure 3 – Finished

- a) Penalties total (penalties assigned plus those for exceeding maximum time)
- b) Penalties assigned

c) total time

2.3.2.3 Confirm

Let's suppose that the first competitor has made a clean run. So we confirm the data acquired by pressing the key <F4> **Confirm**. The final result of the run is printed on the printed strip and REI2 is ready for the run of another competitor.

2.3.3 Another competitor

The next competitor to start is number 23.

To set the new number at the start we press <2> <3> on the keyboard and confirm with <ENT>.

2.3.3.1 Start of countdown

The signal has been given for the competitor at the start to begin (ringing of bell). We press the key <LAP> to start countdown. The number of the competitor and of the run in progress are shown on the printout.

2.3.3.2 Suspension of countdown

Let's suppose that for some reason countdown must be suspended. Countdown is suspended by pressing the <LAP> key on **REI2** or alternatively by pressing a button inserted on the <LAP> line that the President of the Jury can operate. The value of the countdown at the moment it is suspended is printed on the printed strip. Reactivation is effected by pressing the <LAP> key on **REI2** again or alternatively by pressing the button inserted on the <LAP> line that the President of the Jury can operate. The duration of suspension is printed on the printed strip. Suspension and resumption can be repeated as many times as required.

2.3.3.3 Start of race

Let's allow the countdown to run until it reaches 0. When it does so, the race time count begins and on the printed strip **START -0.00s** is written to indicate that the competitor has not started in the countdown time at his/her disposal and the delay in starting is included in the race time. When the competitor crosses the start, REI2 prints the delay in crossing.

2.3.3.4 Penalties

During the the run a penalty of 4 points is assigned for the knocking down of an obstacle. To insert the penalty, press the key <F2> **Pen**. The display appears as shown in Figure 4 with the request to insert the penalty. There are two possibilities: either we key in the value of the penalty and confirm it with the <ENT> key or, more conveniently, we press the function key associated with penalties, in this case <F2> again for 4.

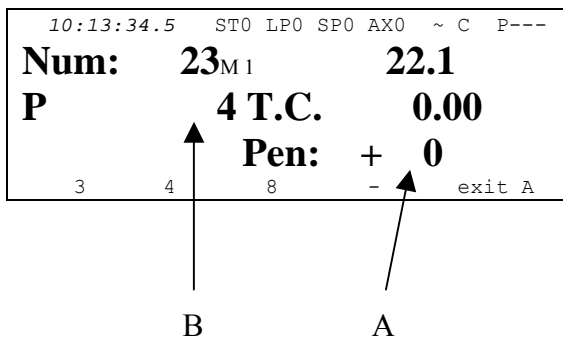

Figure 4 – Insertion of penalty in points

- Penalty to be inserted
- Penalty points assigned

When the penalty has been inserted, this appears on the display next to the letter **P** and is shown on the printed strip.

2.3.3.5 Time correction

If the horse baulks and knocks down an obstacle, another type of penalty is imposed. The time must be stopped to allow the obstacle to be rebuilt. The time interruption mode is the same as that described in chap. 2.3.3.7 Time count suspension on p. 14 The display looks as in figure 5. The penalty is calculated in seconds to be immediately added to the race time. To assign this type of penalty, for example 4 seconds, we press the key <F2> for **4.00s**. Also in this case there are two possibilities: we can either key in the penalty and confirm it with the <ENT> key, or more conveniently press the function key associated with the penalty, in this case <F2> again for **4**.

To correct the time without stopping the run, press <F3> **T.C.**

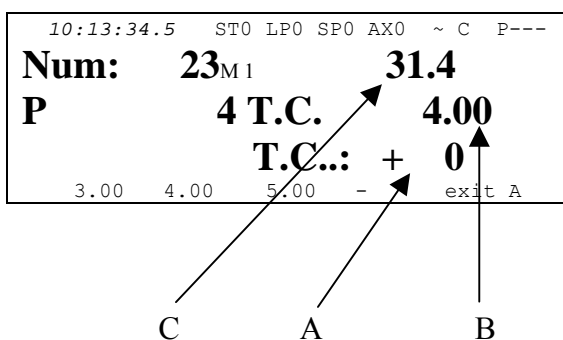

Figure 5 – Time penalty insertion

- The penalty in seconds to be inserted
- The penalty imposed in total time
- The updated time with the penalty already added.

When the penalty has been inserted, this appears on the display next to the letters **T.C.** and is shown on the printed strip.

2.3.3.6 Penalty for refusal

The assignment of a penalty after a refusal is analogous to that for normal insertion, with the difference that the refusal can be indicated on the printed strip. To try it, let's press the key <F2> **Pen** and then press the <ALT> key and keep it pressed down. On the last line the values of the penalties are followed by the letter **R**. To assign the four points, we press the key <F2> for **4R** and release the <ALT> key. The indication ****Refuse**** appears on the printed strip before the penalty indication.

2.3.3.7 Time count suspension

As for the countdown, it is also possible to suspend the time count during the run. The count is suspended by pressing the key <LAP> on **REI2** or alternatively by pressing a button inserted on the <LAP> line that the President of the Jury can operate. The count value at the moment of suspension is printed on the printed strip and **REI2** sets itself for penalization given as a time. If no penalty is to be imposed, quit by pressing the function key <F5> **quit**. Reactivation is effected by pressing the <LAP> key on **REI2** again or alternatively by pressing the button inserted on the <LAP> line that the President of the Jury can operate. The duration of suspension is printed on the printed strip. Suspension and resumption can be repeated as many times as desired.

2.3.3.8 Finish and confirm

The competitor is not able to finish the run within the maximum time set, so we let the stopwatch run. When the count has reached 55 seconds, REI2 emits a beep every second until the end of the maximum time. When the maximum time is exceeded, 1 point for every 4 seconds begun will automatically be added to the penalty points inserted while the information on the display changes as indicated in Figure 6

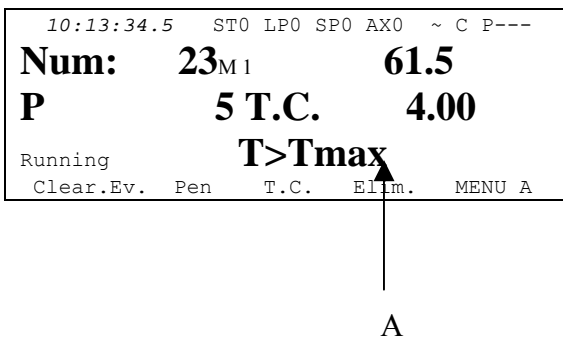

Figure 6 –Maximum time exceeded

- a) Warning that maximum time has been exceeded

We let the count run for about 75 seconds, then we press <STO> to finish the race. The count on the display stops, see Figure 7. By pressing <F4> **Confirm** we confirm the end of the race and obtain a comprehensive data printout (see Figure 12 on p.37).



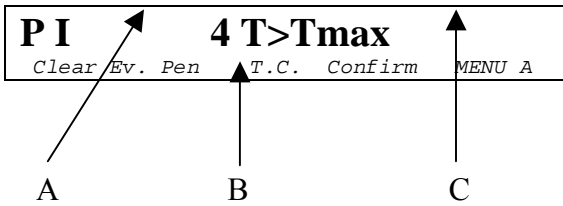

Figure 7 – End of race

- a) Penalty in total points
- b) Penalty in assigned points
- c) Penalty as time correction

2.3.4 Quitting timing

Having finished our brief competition, we quit the timing function by choosing the option **MENU** with the key <F5> The display has now returned to text mode.

2.4 Consecutive barrage

Now let’s simulate a short ‘Consecutive barrage’ race.

After quitting the previous timing session, we find ourselves in text mode again with the first choices from the menu on the display.

We advise beginning a new **Show Jumping** race so the previous configuration should be deleted.

2.4.1 Choosing configuration

```

Hh:mm:ss.d           M 1
A:Timing
B:Input/Printout groups
C:Ranking and other printouts
D:Departure manager

A      B      C      D      other

```

We press <F5> **other** to pass to the menu **M2** and then <F5> **other** again to pass to the menu **M3**

```

Hh:mm:ss.d           M 3
A:REI2 setup
B:Displayboards Setup
C:Input Lines Setup
D:Speed bases Setup           (Disab.)

A      B      C      D      other

```

and select **REI2 Setup** with the key <F1>

```

Hh:mm:ss.d           M 3/1
A:Software setup
B:Hardware setup
C:Serial ports setup
D:Printout Stopwatch setup

A      B      C      D      other

```

<F1> again for **Software setup**

Now we press the key <F1> **Ph.:** until the indication **Ph.:Barrage cons.** appears on the line identified by the letter A.

```

Hh:mm:ss.d      M 3/1/1

A:Ph. :Barrage cons.
B:Penalty settings
C:Table Ph1/sing.:A
D:Table Phase 2 : A

      A          B          C          D          other
  
```

Now we return to timing by pressing first the key **<ESC>** to return to the menu **M1**. The default configuration is printed on the printed strip. Then we press the key **<F1>** for timing.

The display returns to 'graphic' mode.

The information shown on the display is the same as the information seen before Figure 1) with the exception of the indication of the phase number.

A

↓

```

10:12:34.5  SM LPO SPO AX0 ~ C P---
P 1
Num: 24R1 - 45.0

Memo Run Forerunner Confirm MENU A
  
```

Figure 8 – Consecutive barrage: competitor number request

In the various positions we see:

- a) The phase number

For the first phase the preset configuration is the same as the one seen before. The MaxT and Tlim times of the second phase are the same as those of the first phase, as is the FISE table used. The countdown time, on the other hand, is 45 seconds. Between the end of the first phase and the beginning of the countdown of the second, if the competitor has the right to continue because he/she has no faults, the **REI2** stopwatch counts 15 seconds, sounding the last 5 with the beeper. It then stops to wait until the countdown for the second phase is begun by the Jury sounding the bell. Pressing the **<LAP>** key begins the countdown for the second phase.

2.4.2 Consecutive barrage: first phase

After confirming the competitor at the start by pressing the key **<F4> Confirm**, we begin the countdown by pressing the key **<LAP>**. After a few seconds, we press the key **<STA>** to start the competitor and after about another 50 seconds we simulate the end of the first phase by pressing the key **<STO>**.

2.4.3 Consecutive barrage: between first and second phase

When the first phase is finished, the display appears as shown in Figure 9.

A

B

↓

|

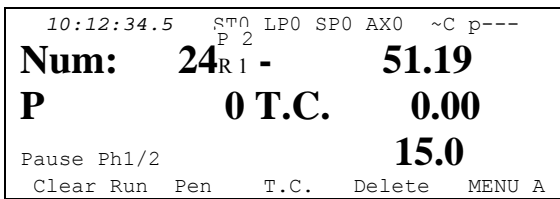

Figure 9 – Consecutive barrage: between first and second phase

In the various positions we see:

- a) The changed phase number.
- b) 15 seconds to be counted down

2.4.4 Consecutive barrage: second phase

When the key <LAP> is pressed, countdown for the start of the second phase begins. The word **Countdown** appears on the penultimate line of the display and the countdown is shown on the display.

As in the first phase we give a start signal with the key <STA>, after thirty seconds we simulate an intermediate event with the key <AUX> and when the stopwatch shows 55 seconds we press the button <STO> to simulate the finish.

Confirmation of the result is given as seen before by pressing the key <F4> for **Confirm**.

2.4.5 Consecutive barrage: elimination after first phase

Let's see what happens if a competitor incurs penalties during the first phase.

We confirm the competitor at the start with <F4>, we begin the countdown with <LAP>, and we start him/her with <STA>. After a few seconds we assign a penalty by pressing first key <F2> **Pen** and then key <F2> for **4** points. 4 penalty points are shown on the display.

We simulate the finish by pressing the key <STO>. Now the competitor has incurred penalties and cannot run the second part of the race. On the printed strip **Run ended after phase 1** is printed, and after the result has been confirmed with <F4> the results obtained are printed and elimination is signalled with the indication **Elim. after ph.1**.

2.5 End of race operations

In Show Jumping the disqualification of a competitor is a very rare and extremely serious event and to indicate that a competitor has been removed from the competition but is inserted in the ranking (e.g. for a fall, double refusal, taking the wrong course, etc...) the term **Elimination** is used. Consequently, the REI2 program does not envisage a competitor's withdrawal so elimination is used.

2.5.1 Eliminations

```
Hh:mm:ss.d           M 1
A:Timing
B:Iinput/Printout groups
C:Ranking and other printouts
D:Departure manager

A      B      C      D      other
```

To eliminate a competitor, for example, N° 8, we scroll the menu (**other**) with the <F5> key

```
Hh:mm:ss.d           M 2
A:Synchronization
B:Eliminations
C:Download data to PC
D:Upload data from PC

A      B      C      D      other
```

and we select **Eliminations** with the <F2> key.

```
Hh:mm:ss.d           M 2/2
  ATHLETE ELIMINATION MANAGEMENT

Number =   0      Manche = ---

Status =

Modify  Other                                menu
```

The cursor appears next to the word **Number** and we press <1> <ENT>

```
Hh:mm:ss.d           M 2/2
  ATHLETE ELIMINATION MANAGEMENT

Number =   1      Manche = ---

Status =

Modify  Other                                menu
```

The cursor appears next to the word **Run** and we press <1> <ENT>

```
Hh:mm:ss.d           M 2/2
  ATHLETE ELIMINATION MANAGEMENT

Number =   1      Manche = 1

Status =  QUALIFIED

Modify  Other                                menu
```

REI2 has searched for the status of the specified competitor for the specified run. We mark the competitor as eliminated by pressing <F1> **Edit**

```
Hh:mm:ss.d           M 2/2
  ATHLETE ELIMINATION MANAGEMENT

Number =   1      Manche = 1

Status =  ELIMINATED

Modify  Other                                menu
```

We insert the elimination by pressing <F5> **menu** to quit and then <ESC> to return to menu number 1.

2.5.2 Printing of ranking

```
Hh:mm:ss.d          M 1
A:Timing
B:Insertion/printout of groups
C:Rankings and other printouts
D:Start management
A          B          C          D          other
```

To print the ranking we select **Rankings and other printouts** with the key **<F3>**.

```
Hh:mm:ss.d          M 1/3
A:Print/Show ranking
B:Other printouts
C:Printout and Visualization mode
A          B          C          quit
```

Now we select **Print/Show ranking** with the **<F1>** key.

```
Hh:mm:ss.d
A:Ranking_____ Stop Times
B:Based on_____ Phase 2
C:Run_____ 1
D:Group (0=all numbers) 0
E:Take other run: No
ESC= quit ENT=show ALT+ENT=print
A          B          C          D
```

A panel is presented for selecting the type of ranking. For the moment we will just print by pressing **<ALT>+<ENT>**. On the printout the contents of the panel will be given, followed by the printout of the ranking.

2.5.3 End of session

```
Hh:mm:ss.d          M 1/3
A:Print/Show rankings
B:Other printouts
C:Printout and visualization mode
A          B          C          quit
```

To conclude this first overview we press the **<ESC>** key, **quit**, to return to the printout menu and then

<F5> for **quit**

We have now returned to the main menu and can switch off our REI2 with the relative switch.

```
Hh:mm:ss.d
*****
Are you sure you want to switch off the
stopwatch
*****
SWITCH OFF          STANDBY          CONTINUE
```

Before switching off, REI2 asks for confirmation, which is given by pressing the **<F1>** key for **SWITCH OFF**.

3 Program characteristics

In the short race illustrated in 'Starting', we have used only a minimal part of the function features offered by the 'Show jumping' program. In the following sections the various configuration possibilities and the various operations to be performed for particular events will be analysed

REI2 stores all the events (start, intermediate, stop) and allows you to make all the modifications that may become necessary at any time, also of finished runs. The values that depend on the edited events (net time, lap time, total times.....) are recalculated after each modification.

On the printout all the events recorded are shown with the indication of the type, competitor number, run, channel type, channel and time and all the modifications made to them (annulments, variations, re-assignments...).

Firstly the functions available within the Timing function will be illustrated. Then the possibilities which can be accessed from the program menu will be illustrated.

The various choices possible, both as regards the various menus and options and the various editable values, are assigned each time by the 5 function keys <F1> <F2> <F3> <F4> <F5>.

Times are taken with an accuracy of 1/25,000 of a second; they are printed and displayed with an accuracy of 1/10,000. All the calculations are made at 1/25,000 and then net times are rounded off.



The storage of all the events and the calculation of results when needed allows maximum flexibility of race management, such as the editing of events for previous runs, re-printing of the rankings of runs already completed, the simultaneous management of two or more runs or even starting competitors with their run order inverted.

This manual refers to version 1.07.9.

4 Timing

4.1 Functional context

The various functions are associated with the 5 function keys in different ways according to the events to be managed, the 'virtual keyboard' enabled and whether an operation on the 'proprietary' start number is necessary.

In the first sessions you are therefore advised to check the function associated with the different keys, which is always shown on the display, before pressing them.

Below are shown the various active functions within the various 'statuses' in which REI2 can operate during the timing session, and the section in which their use is described.

Statuses:

- **Ready:** there are no events to manage or numbers to confirm/change
- **Initial confirmation:** the operator is ready for a new competitor.
- **Countdown:** the competitor has entered the arena and has been authorized to start.
- **Race in progress:** a Start impulse has been acquired.
- **Finished:** a Stop impulse has been acquired.

The functions active in 'ready' status are:

- **Memo**4.7.4 Memo 30
- **Run**4.7.5 Run in progress 31
- **Forerun..**4.7.6 Forerunner mode 31
- **Confirm** 4.3.2 Initial confirmation of competitor 24
- **Rank. (*)**.....4.3.15 Ranking activation 28
- **Race setup (*)** 4.3.2 Initial confirmation of competitor 24

- **Memo.**
 - **←**4.7.4 Memo 30
 - **→**4.7.4 Memo 30
 - **Search**.....4.7.4 Memo 30
 - **Print**.....4.7.4 Memo 30
 - **C.Sta. (*)**4.7.4.1 Correction of time event 31
 - **C.Sto. (*)**4.7.4.1 Correction of time event 31
 - **Pen. (*)**4.3.6 Points penalization 26
 - **T.C. (*)**4.3.7 Penalization as time correction 26
 - **Quit**.....4.7.4 Memo 30
- **Menu** 4.11 Quitting timing 34

The functions active in 'Initial confirmation' status are:

- **Clear**4.7.1 Annul 30
- **Pen**
- **Clear run**..... 4.7.3 Race annulment 30
- **Delete**..... 4.3.8 Elimination 27

- **MENU** 4.11 Quitting timing 34

The functions active in ‘countdown’ status are:

- **Clear** 4.7.2 Event annulment 30
- **Pen.** 4.3.6 Points penalization 26
- **Clear run** 4.7.3 Race annulment 30
- **Delete** 4.3.8 Elimination 27
- **MENU** 4.11 Quitting timing 34

The active functions in ‘race in progress’ status are:

- **Clear Ev** 4.7.2 Event annulment 30
- **Pen.** 4.3.6 Points penalization 26
- **T.C.** 4.3.7 Penalization as time correction 26
- **Delete** 4.3.8 Elimination 27
- **C.PH1⁽¹⁾** 4.7.8 Phase 1 correction 32
- **Clear run (*)** 4.7.3 Race annulment 30
- **Pen(**)** 4.3.6 Points penalization 26
- **Continue(*)⁽¹⁾**
- **Delete F2(*)⁽¹⁾** 4.3.8 Elimination 27
- **MENU** 4.11 Quitting timing 34

The functions active in ‘finished’ status are:

- **Clear Ev** 4.7.2 Event annulment 30
- **Pen.** 4.3.6 Points penalization 26
- **T.C.** 4.3.7 Penalization as time correction 26
- **Confirm** 4.3.14 Confirmation of results 28
- **Clear run (*)** 4.7.3 Race annulment 30
- **Pen(**)** 4.3.6 Points penalization 26
- **Delete (*)** 4.3.8 Elimination 27
- **MENU** 4.11 Quitting timing 34

The functions marked with (*) can be accessed by pressing the key <ALT> and the corresponding function key.

The functions marked with (**) are always available whether the key <ALT> and the corresponding function key are pressed or not.

The functions indicated by ⁽¹⁾ are only available during the second phase.

4.2 Starting a session

To begin a timing session (race), after you have chosen the option for the race a request appears asking you to select the program required.

This program illustrates the functioning of the 'Show Jumping' program, so press the key <F5> for **other** and then <F1> for **Show Jumping**.

If the last competition before switching off REI2 or the one previously being used was **Show Jumping**, the program proposes <F1> **Clear previous configuration**, <F2> **Keep last race configuration**.

If a previously used configuration is stored and you intend to use it (automatisms, truncations, holdoff times, displayboard settings, etc....), press <F2> for **Keep configuration of last race**.

If, on the other hand, you wish to change the configuration used, press <F1> for **Delete previous configuration**. To confirm that you wish to annul the set configuration, press <F4> for **Yes**. If you make a mistake or change your mind, press <F5> for **No**. When the previous configuration has been deleted, REI2 activates the default configuration, see example on p.10 chap.2.3.

Then to activate the session, press <F1> for **Timing**.

There are two ways of changing the default settings:

A: In **Ready** status, if the key <ALT> is pressed and kept pressed down, the option **Race setup** appears above the function key <F1>. By pressing <F1> you immediately access the menu **M 3/1/1**.

B: By following the procedure indicated on p. 15 chap. 2.4.1

The only difference between the two methods is that option **A** must be used without any competitors running while if you have a good knowledge of REI2, you can use it also with the competitor running without interrupting timing and displayboard viewing.

To reactivate the session, press the key <ESC> **quit**, and then the key <F1> for **Timing**.

The configuration set is printed on the printed strip.

4.3 Single phase competition

4.3.1 Number currently racing

REI2 offers various possibilities for the management of starts. Lists can be managed manually, calculated from total results or previous runs and uploaded from PC. For details about the management of start lists, refer to chap. 7.2 Start order calculation on p.45.

As more fully illustrated below, REI2 allows you to vary times and start numbers both immediately after a competitor's start and later also for competitors who in the meantime have reached the finish. All the data obtained (net time, intermediate time, penalties, etc.) is recalculated by REI2 without the user having to make further operations. If no list is inserted, the start numbers are proposed in sequence.

4.3.1.1 Change of race number

To change the competitor number, simply key it in by pressing the corresponding figures on the keyboard. When the first numeric key is pressed, the corresponding number is written next to the letters **Num** and the cursor appears next to it for the insertion of further figures. To confirm the number, press <ENT>. In addition, the arrows can be used to run through the bib numbers of the next athletes in the competition. The highest number which can be set is 999.

REI2's behaviour changes according to whether events (start of countdown, start, etc.) have been previously assigned to the various race numbers. The following table summarises the different ways it behaves.

| Initial number (for example 5) | New number (for example 9) | Behaviour (run number set 1) |
|--|--------------------------------------|--|
| No event | No event | The competitor number is substituted |
| No event | Events assigned | Substitution accepted. N.xxx subst. with N.yyy is shown on the printed strip where xxx is the old number and yyy the new number. (N. 5 subst. with N. 9) |
| Events assigned | No event | On the display an error message is shown: ATTENTION Competitor... ; pressing <F1> for Delete deletes the result previously acquired for that competitor, pressing <F5> Quit takes you back to 'ready' status without making modifications |
| Events assigned | Events assigned | Substitution not accepted, indicated by Number in use ! on the display |



The race number can be edited in the same way at any moment: before or after the start of countdown, after the start or finish or by calling up the numbers which have already finished (**Memo** Function).

4.3.2 Initial confirmation of competitor

To confirm the number at the start, press the key <F4> for **Confirm**. The message **Lap=Start Countdown** appears on the penultimate line of the display.

If the countdown time is set to zero (see chap. 12.1.12 Start time on p.59), the start is free. In this case, after confirmation of the competitor, the stopwatch waits for the start signal and the message **Wait for start** appears on the penultimate line of the display.

4.3.3 Start of countdown

An impulse from the Lap line or the <LAP> key starts countdown. The initial countdown value can be set with the function 12.1.12 Start time (on p.59). The diminishing time remaining is shown with the symbol -.

When zero has been reached, if the 'Take delay after countdown' function is active, the start automatically takes place, if not, counting up from 0 restarts and is shown with the symbol +.

4.3.4 Count suspension

After countdown has begun, a lap event suspends it, whether it comes from the lap line or is generated by pressing the key <LAP>. As in the countdown, it is also possible to suspend the time count during the run. However REI2 behaves differently in the two cases.

The countdown is suspended by pressing the key <LAP> on **REI2** or alternatively by pressing a button inserted on the <LAP> line that the President of the Jury can operate. The countdown value at the moment of suspension is printed on the printed strip. Countdown reactivation is effected by pressing the <LAP> key on **REI2** again or alternatively by pressing the button inserted on the <LAP> line that the President of the Jury can operate. The duration of suspension is printed on the printed strip. Suspension and resumption can be repeated as many times as desired.

The lap event will restart counting from where it was interrupted.

The count is suspended during the run by pressing the key <LAP> on **REI2** or alternatively by pressing a button inserted on the <LAP> line that the President of the Jury can operate. The count value at the moment of suspension is printed on the printed strip and **REI2** sets itself for penalization given as a time. If no penalty is to be imposed, quit by pressing the function key <F5> **quit**. Reactivation is effected by pressing the <LAP> key on **REI2** again or alternatively by pressing the button inserted on the <LAP> line that the President of the Jury can operate.

Although the race time has started running again, it will not be shown on the display until you have quit penalization as a time by pressing the function key <F5> **quit**.

When the count restarts, the time passed from the beginning to the end of the suspension is printed.

No check is made on the duration of a single suspension or on the number and total time of the suspensions made.

4.3.5 Start of race

The start event blocks the countdown, if activated, and starts the counting of race time.

REI2 behaves in different ways according to whether the start time has ended or not and the configuration inserted in 12.1.8 Take delay after countdown (see p.58).

| Countdown | Consider delay after countdown | printed | Race time count |
|------------------|---------------------------------------|---|------------------------|
| Not ended | ... | START (-) in front of counting of countdown | Starts from 0 |
| Ended | Yes | START (-) 0.00 for end of countdown | Starts from 0 |
| Ended | No | END COUNTDOWN! START and counting of countdown | Starts from 0 |

4.3.6 Points penalization

To assign a penalty, press the key <F2> for **Pen**.

The indication **Pen:** appears on the display and next to it the cursor waits for a value to be inserted. There are two ways of inserting the penalty: keying the value in and confirming with <ENT> (the highest value which can be set is 600) or pressing the function key related to the correct penalty. If the penalty is due to a refusal, indication of the refusal can be printed by confirming with <ALT>+<ENT>.

Assignment of the penalty is shown on the printed strip with the indication **Penalty** and the relative points. The total on the display is immediately updated.

The enabled function keys are:

- <F1>, <F2> and <F3> to assign the penalty related to the key
- <F4> each time this is pressed, the sign of the penalty to be inserted changes from + to – and viceversa
- <ALT>+<F1>, <ALT>+<F2>, <ALT>+<F3> to assign the penalty related to the key with the indication ****refuse**** on the printed strip
- <F5> **quit** to quit the penalty assignment function
- <ESC> if kept pressed down, deletes any figures inserted and quits the function.

If a penalty has been wrongly assigned, it can be deleted by inserting it again with the sign inverted. Inversion of the sign with <F4> functions both for penalties keyed in and confirmed with <ENT> and for those inserted with the function key. The sign can be seen next to the indication **Pen:**.

The values of penalties associated with the various function keys can be set with the function 12.1.2 Penalty settings (on p.57).

If the points competition function is active, it is possible to quit the penalty insertion menu only if 0 is entered and <F5> pressed.

4.3.7 Penalization as time correction

To assign a time penalty, press the key <F3> for **T.C.**.

The indication **T.C.:** appears on the display with next to it the cursor, which waits for a value to be inserted. As in the case of the insertion of penalty points, there are two possible ways of inserting the penalty: keying in the value and confirming with <ENT> or pressing the function key associated with the correct penalty.

Indication of the time correction **T.Corr.** is shown on the printed strip with the time inserted. The total on the display is immediately updated.

The enabled function keys are:

- <F1>, <F2> and <F3> to assign the penalty related to the text
- <F4> - each time this is pressed, the sign of the penalty to be inserted changes from + to – and viceversa
- <ALT>+<F1>, <ALT>+<F2>, <ALT>+<F3> to assign the penalty related to the text with the indication ****refuse**** on the printed strip
- <F5> **quit** to quit the penalty assignment function

- <ESC> if kept pressed down, deletes any figures inserted and quits the function.

If a penalty has been wrongly assigned, it can be deleted by inserting it again with the sign inverted. Inversion of the sign with <F4> functions both for penalties keyed in and confirmed with <ENT> and for those inserted with the function key. The sign can be seen next to the indication **T.C.**.

The values of penalties associated with the various function keys can be set with the function 12.1.2 Penalty settings (on p.57).

Time correction penalization immediately affects the total time taken, also as regards the calculation of the penalty for exceeding maximum time.

4.3.8 Elimination

Allows you to immediately eliminate the competitor running at that moment. You are asked to confirm that you wish to delete the competitor. To delete, press <F4> for **Yes**, if you do not wish to delete, press <F5> for **No**.

Immediately after elimination, the next competitor is proposed at the start and must be confirmed with the function key <F4> .

4.3.9 Time about to run out

During the race REI2 can signal the last 5 seconds before the end of each event with a time limit (countdown, end Tmax, end Tlim, pause Ph1/Ph2, etc....) through activation of the function 12.1.21 Sound counter (see p.61).

4.3.10 Penalization for exceeding maximum time

If the maximum time set with the function 12.1.13 Maximum (see p.59) is reached, a situation shown on the display with the indication **T>Tmax**, for each second begun, the penalties specified with the function 12.1.5 Maximum time penalty - phase1/single (see p.58) are assigned. 'Maturation' of the penalties automatically assigned is immediately shown on the display next to the item **P**.

4.3.11 Automatic elimination

When the time limit set with the function 12.1.14 Time limit value (see p.60) plus one hundredth of a second is reached, the time count stops and the indication **Elim. T>Tlim** appears on the penultimate line of the display to communicate that the competitor has been eliminated. Exceeding the set time limit results in the printing on the printed strip of the time limit reached and the indication **Elim. for T>Tlim**.

4.3.12 Intermediate event

Only in the final phase (first phase for 'single phase' or second phase in the '2 phase' or 'consecutive barrage' modes) is an event coming from the AUX line or from the LAP1 radio interpreted as intermediate. The intermediate time blinks on REI2's display for 5 seconds and is printed on the printed strip.

Any other event (penalization, end of run, etc.) interrupts display of the intermediate event and restores the normal mode.

4.3.13 End of race

The STOP/START event ends the race. The total time, taking into account time correction penalties assigned, total penalty points, penalty points incurred by knocking down obstacles, refusals and any falls are shown on the display.

After the time count has been stopped, further penalties, both in points and time correction, can be assigned. If the 'time corrections' cause the maximum time to be exceeded, the relative penalty points are automatically calculated and added.

If the FISE table set for the phase in progress (see 12.1.3 Table Ph1/sing. on p.57) is 'C', also the total time, obtained by adding actual time + time correction + penalties assigned is shown on the display.

The position in the provisional ranking is shown in the top right corner of the display until the result is confirmed.

4.3.14 Confirmation of results

When the race is over, press the key <F4> **Confirm** to obtain a printed summary of the race and store it.

If the FISE table for the phase in progress (see 12.1.3 Table Ph1/sing. on p.57) or if the competitor has been eliminated, after confirmation with the key <F4> **Confirm**, this must be pressed again to confirm the number of the next competitor.

In all other cases REI2 proposes the next competitor at the start, confirming him/her automatically as described in chap. 4.3.2 Initial confirmation of competitor on p.24.

4.3.15 Ranking activation

In **Ready** status, if the key <ALT> is pressed and is kept pressed down, the option **Rank Yes** appears above the function key <F3>. Each time the key is pressed, **Rank Yes** is activated or **Rank No** is disactivated. REI2 will show the position in the ranking at the top right of the display.

4.3.16 Annul race

When the competitor has already started, if the key <ALT> is pressed and is kept pressed down, the option **Clear race** appears above the function key <F1>. If the function key <F1> is pressed, REI2 **Clear race. Sure?** Press <F4> **Yes** to annul, <F5> **No** if you decide not to annul.

4.4 2 phase progressive time competition

Functioning in '2 phase progressive time' competition mode is similar to functioning in 'single phase' competition mode.

On the display, the indication **Ph1** for the first phase or **Ph2** for the second phase appears next to the competitor's number.

A different FISE penalty table for the second phase can be specified by using the function 12.1.4 Table Phase 2 (p.58).

If the maximum time value to be set in the first phase is greater than 60 seconds (the second phase default value), for three seconds REI2 shows the message **Tmax Ph1 must be lower than Tmax**

Ph1+Ph2 on the last line of the display. So key in a value equal to or less than 60 seconds and confirm with **ENT** by pressing the function key <F5> **other**. Go to the **Ph2** menu by pressing the function key <F3> **Max T.Ph1+2**, set the total time and confirm with **ENT**. Then you can return to the settings menu of **Ph1** by pressing the arrow key <Up> and key in the desired **Tmax** value.

The values for maximum time and the time limit of the second phase can be defined completely independently from those set for the first phase by using the functions 12.1.17 Phase 2 maximum time (2,S,C) (p.60) and 12.1.18 Phase 2 time limit (2,S,C) (p.60). As in the previous paragraph, it is not possible to enter a value lower than the maximum time or time limit for the first phase, for three seconds REI2 makes the message **Tmax Ph1+Ph2 must be greater than Tmax Ph1** blink on the last line of the display, the setting is not accepted and the value must be modified with the total time **Ph1+Ph2**.

4.4.1 End of first phase

An event coming from the STOP/AUX/START line is interpreted as the signal for the first phase and the simultaneous start of the second phase, depending on the settings given in the first phase with the function key <F1> **Finish signals**.

A competitor who incurs penalties during the first phase is excluded from the second phase unless otherwise specified with the function 12.1.15 Delete after first phase: (2,S,C) (see p.60) or unless he/she has only exceeded the maximum time for the first phase and the Jury decides to allow the race to be concluded before possibly modifying the maximum time of the first phase. In this case, if the key <ALT> is pressed and is kept pressed down, the command **Continue** appears on the function key <F3>. Keeping the key <ALT> pressed down, press <F3> and after 2 seconds the words **Continue Sure? <F4> Yes; <F5> No** appear on the last line of the display. If you confirm with <F4> **Yes**, the race continues without taking into account that the maximum time of the first phase was exceeded, and can be concluded.

During the second phase it is possible to modify the penalties inserted during the first phase with the key <F4> **C.Ph1**.

To eliminate a competitor in the second phase, press the key <ALT> and keep it pressed down. The command **Delete** appears associated with the function key <F4>. In this way the competitor running at that moment can be immediately eliminated. You are asked to confirm that you want to eliminate the competitor. To eliminate, press <F4> for **Yes**, if you do not want to eliminate, press <F5> for **No**. Immediately after elimination the next competitor is proposed at the start and must be confirmed with the function key <F4>.

The time of the second phase starts from the value reached at the end of the first.

4.5 2 phase separate time competition

Functioning is exactly the same as for the '2 phase progressive time' competition, but the time of the second phase restarts from zero. The final time is given only by the time of the second phase. For calculation of the ranking, the time of the second phase, that of the first one or the total of the two times can be used.

There are no compulsory parameters to observe when setting **Tmax**, either for the first or the second phase.

4.6 Consecutive barrage competition

The main difference compared with the '2 phase' competition is the presence of a pause, which can be defined with the function 12.1.10 Phase 1-phase 2 (see p.59), between the end of the first phase and the beginning of the second phase.

The value of the second phase countdown can be defined completely independently from the value for the first phase by using the function 12.1.16 Phase 2 start time (2,S,C) (p.60).

4.7 Functions

4.7.1 Annulment

When this function is used, confirmation of the number of the competitor at the start is annulled.

4.7.2 Event annulment

The function **Clear.Ev.**, usually associated with the key <F1>, allows you to delete stored events beginning from the last one received. Each time you press the key, you are asked to confirm that you want to delete. To delete an event, press the key <F4> for **Yes**. If you make a mistake, you can abandon deletion by pressing <F5> for **No**.

4.7.3 Race annulment

This function allows you to completely delete a competitor's race . If deletion is made before any event has been acquired, the number of the competitor at the start is not increased. If it is made after an event has been acquired, the next competitor is placed at the start.



REI2 asks for confirmation with **Clear race. Sure?** that you want to delete the race. To confirm deletion, press <F4> for **Yes**, otherwise press <F5> for **No**.

The race number of a competitor whose race has been deleted can subsequently be used without any limitation, as if that competitor had never started.

4.7.4 Memo

The **Memo** function allows you to call up the results of competitors who have previously performed the race and, where necessary, to correct them.

The options available are:

- <F1> : to scroll the list of competitors in inverse order to the one in which they performed the race. When you reach the first competitor of a run, you pass to the last competitor of the previous run. When there is more than one phase, for each competitor the various phases are then shown.
- <Arrow up >: as for <F1> but the various phases are not shown
- <F2> : as for <F1> but in the order in which the race was performed
- <Arrow down >: as for <F2> but the various phases are not shown
- <F3> **Search**: allows you to rapidly call up the race you want. When you press the key, the cursor appears next to the number and after insertion and confirmation, next to the run number. When this has been confirmed, you are asked for the phase number. If the race you are looking for is not present, an error message is shown on the last line for a few seconds

- **<F4> Print:** to print the competitor's final results
- **<ALT>+<F1>C.Sta.:** allows you to correct the start time (see 4.7.4.1 Correction of time event on p.31)
- **<ALT>+<F2> C.Sto. :** allows you to correct the stop time (see 4.7.4.1 Correction of time event on p.31)
- **<ALT>+<F3>Pen. :** to access the function 4.3.6 Points penalization (p.26)
- **<ALT>+<F4> T.C.:** to access the function 4.3.7 Penalization as time correction (p.26)
- **<F5> Quit:** to quit the function.

To change the number assigned to a race, follow the instructions in chap. 4.3.1.1 Change of race number on p.23.

4.7.4.1 Correction of time event

When this function is accessed, the time event, Start or Stop, on which you have decided to work is shown at the top right of the display. Now the correct time event can be inserted. The following function is also available:

- **<F1> C.Date** to change the event date

The correction made is printed on the printed strip. Net time and any penalties for exceeding the maximum time are recalculated.

4.7.5 Run in progress

To set the number of the run in progress, press the key **<F2> Run** in 'ready' status, insert the number of the run in progress and press **<ENT>** to confirm.

If the run is new and so no competitor has taken part, it is possible to modify the configuration of the competition in all the parameters that can be set. REI2 will operate as if it was a new competition. Remember that in the management of printing/rankings display, it will obviously be necessary to set the right run.

If a competitor has already made the run, even if eliminated, when his/her number is keyed in, confirmed and indicated on the display, an error message **'ATTENTION The competitor n.x. run n.x. already present in memory'** is shown. Pressing **<F1>** for **Delete** deletes the result previously acquired for that competitor. The result can be displayed on the displayboard by pressing **<F3>**. Pressing **<F5> Quit** restores 'ready' status without making any changes.

4.7.6 Forerunner mode

While REI2 is in 'ready' status, pressing the key **<F3> Forerunner** activates 'forerunner mode', once again in 'ready' status. Pressing the key **<F3>Dis.Forerunner** returns you to the normal mode.

After you have entered the **Starts** configuration with **<F5> >>>>** and **<F1> C.Start**, each time you press the **<F4> Forerunner** key, the 'forerunner' mode is activated or deactivated. For each mode change, confirmation is requested with the question **'Activate forerunner mode?'** or **'Quit forerunner mode?'** Confirm with **<F4> Yes** to change the status or **<F5> No** to annul the change. Each status change is shown on the printout, framed by asterisks so that it can be quickly ascertained.

While the forerunner mode is active, the displayboard is deactivated and the relative red led on the stopwatch (the displayboard can be activated) blinks. The management of the forerunner remains exactly the same as for normal management with the difference that the forerunner does not appear in the ranking.



When you quit forerunner mode, the data for this mode is deleted from REI2's memory.

4.7.7 Race setup

While REI2 is in 'ready' status, pressing the key <ALT>+<F1> **Race setup** accesses the menu M 3/1/1 where the settings which guide the functioning of the program can be found. (see note in chap. 4.2p. 23 and 12.1 Software setup see p.57)

4.7.8 Phase 1 correction

While the second phase is in progress, corrections can be made to the values of the first phase by accessing the function **C.Ph1** with the key <F4>. The indication **Corr.Ph1!** appears on the penultimate line of the display and the following functions are enabled:

- <F2> **Pen.** to access the function 4.3.6 Points penalization (see p.26)
- <F3> **T.C.** to access the function 4.3.7 Penalization as time correction (see p.26)
- <ESCI>: to quit the function.

A competitor who incurs penalties while running the basic course is excluded from the barrage unless otherwise specified with the function 12.1.15 Delete after first phase: (2,S,C) (see p.60) or unless he/she has exceeded the maximum time of the first phase and the Jury decides to allow the race to be finished before possibly modifying the maximum time of the basic course. In this case if the key <ALT> is pressed and kept pressed down, the command **Continue** appears on function key <F3>. Keeping the key <ALT> pressed down, press <F3> and after 2 seconds the words **Continue Sure? <F4> Yes; <F5> No** appear on the last line of the display. If you confirm with <F4> **Yes**, the race continues without taking into account that the maximum time of the first phase was exceeded, and can be concluded.

This function is available only in the second phase of the '2 phase' or 'consecutive barrage' competition.

4.7.9 Start of second countdown

Only in the 'consecutive barrage' is it possible to begin the countdown without waiting for the time set in 12.1.10 Phase 1-phase 2 (p.59) to run out.

4.8 Displayboard management

REI2's management of the displayboard/displayboards is very sophisticated. The configuration options of the displayboards installed is illustrated in section Displayboards setup on p.66. In this section, their management during timing will be illustrated.

4.8.1 Normal functioning

During a normal timing session, the data for the competitor in the race, such as countdown running time, the race time, penalties incurred, etc., are shown.

4.8.2 Disabling of displayboard

To deactivate the displayboard output so that no communication appears, press the <ALT> + <Displayboard> keys simultaneously. The red led of the key begins to blink rapidly (about two blinks a second). To reactivate the displayboard, press the <ALT> + <Displayboard> keys again. The indicator stops blinking.

4.9 Lock keys

The two <LCK> keys have similar function features. The only difference is that, while the <LCK> key over the <Stop> button operates only on the stop line, the key over the <Start> button can be configured in whatever way the user likes. In **Show jumping** the latter operates both on the **start** line and on the **aux** or **lap2** line (see section Lines exclusion configuration on p.74).

When activated, with a simple press, the red led corresponding to the key pressed begins to blink. Pressing the LCK key a second time reactivates the line (and turns off the corresponding led). A line can be automatically put in lock status after it has acquired a valid impulse. See chap.12.1.22 Auto lines block after every event on p.61 for further details.



Note that the lock keys function on all the inputs (line, LinkPod ©, radio) assigned to the blocked logical channel. However, they have no effect on the line keys.



The last discarded event acquired by wireless or line transmission can be retrieved by pressing the key <START/STOP> and then pressing the key <F4> in reply to the question 'Manage XXX Sure? Yes No'. Alternatively the last 5 discarded events can be displayed and/or managed by pressing <ALT>+ <Start/Stop>.

The key <LCK> situated above the key <Start> also works on the Stop line if enabled (see 14.3 Lines exclusion configuration on p. 74)

4.9.1 Discarded events management

This function makes it possible to retrieve or delete the last 5 events discarded as a result of a line block.

| hh:mm:ss.d | Logical channel | Physical channel | Date of event | Time of event |
|------------|-----------------|------------------|---------------|---------------|
| LogiC | PhysicC | Time | Date | |
| START | Line | hh:mm:ss.Dcmd | gg/mm/aa | |
| STOP | Line | hh:mm:ss.Dcmd | gg/mm/aa | |
| ---- | ---- | ---:---:---.--- | ---/--/-- | |
| ---- | ---- | ---:---:---.--- | ---/--/-- | |
| ---- | ---- | ---:---:---.--- | ---/--/-- | |
| ↑ | ↓ | Manage | Manage | all Del. |

Options available:

- <F1> ↑ scrolls up the list of the 5 choices available.
- <F2> ↓ scrolls down the list of the 5 choices available.
- <F3> **Manage** manages the selected event.

- <F4> **Manage all** manages all the events in order from bottom to top and quits automatically.
- <F5> **Del.** deletes the event from the list
- <ESC> quits the discarded events management menu.



If you choose to manage or delete an event, this is removed from the list of discarded events.



If other events are discarded when you are in this menu, the list is only updated when you quit.

4.10 Holdoff time disactivation keys

The two <Rearm > keys have similar function features. The only difference is that, while the <Rearm> key over the <STO> button operates only on the stop line, the key over the <STA> button can be configured in whatever way the user likes (see section Lines exclusion configuration on p.74)

Pressing the key once annuls the waiting time set for the lines on which it is configured. In this way REI2 can be set up to receive impulses without waiting for the end of the holdoff time set (see section 14.2 Lines holdoff times on p.73). Annulment of holdoff time, shown by the blinking of the led on the key, remains active until the <Rearm> key is pressed again. Of course, the key has no effect on the holdoff times set on the peripherals (e.g. Polifemo cell).

4.11 Quitting timing

To return to the competition menu at the end of the timing session:

- press the <F5> key for **MENU**.

It is possible to quit the timing menu, make changes and return to timing also during the race. The command and display of any displayboards connected is not interrupted unless it is decided to disactivate them by pressing the keys <ALT>+<Displayboard>. Of course, all the data is retained.

If some events, for example a stop, are acquired, when you return to the timing function the message '**Some events acquired. Delete events?**' appears. To delete the stored events press the <F1> key and then confirm the decision to delete with the <F4> key for **Yes**. If you press <F2> you will return to timing, with the events ready to be managed.

4.12 Printout of time events

REI2 prints all the events, results and all the operations performed on the printout.

Print modes depend on the setting of a number of configuration values in the menu 'Print Time of day' (see p.60).

There are two types of printout:

- Printing of events
- Printing of results.

4.12.1 Printout of events

For each single event which takes place, a line containing information about the acquired event is printed...

Let's have a detailed look:

The diagram shows a printed strip of event data. Above the strip, three arrows labeled A, B, and C point to specific fields. Arrow A points to the race number 'N 23'. Arrow B points to the run number 'Run N.1'. Arrow C points to the 'START' field, which contains the value '-35.53s'.

| | | |
|------------|---------|---------|
| N 23 | Run N.1 | |
| START | | -35.53s |
| Interr. | | 26.94s |
| Tpause | | 4.69s |
| Penalty | | 4.00p |
| T.Corr. | | 4.00s |
| **Refuse** | | |
| Penalty | | 4.00p |
| Interr. | | 12.55s |
| End Ph.1 | | 55.17s |

Figure 10 – printed strip: events

A: Race number

B: Run number

C: Type of event acquired. This can have one of the following values:

- **START** countdown value at the moment of the Start, with the sign '-' if acquired before countdown runs out, with the sign '+' if acquired after
- **Interr.** value of the time count at the moment of interruption
- **Tpause** duration of interruption
- **Penalty** value of penalty in points
- **T.Corr.** value of penalty as time correction
- ****Refuse**** indication of refusal, indicates that the following penalty was inserted after a refusal
- **Interm.** intermediate event acquired
- **End Ph1** final time of first phase in races which have more than one phase

... and particular situations are indicated.

Let's have a detailed look:

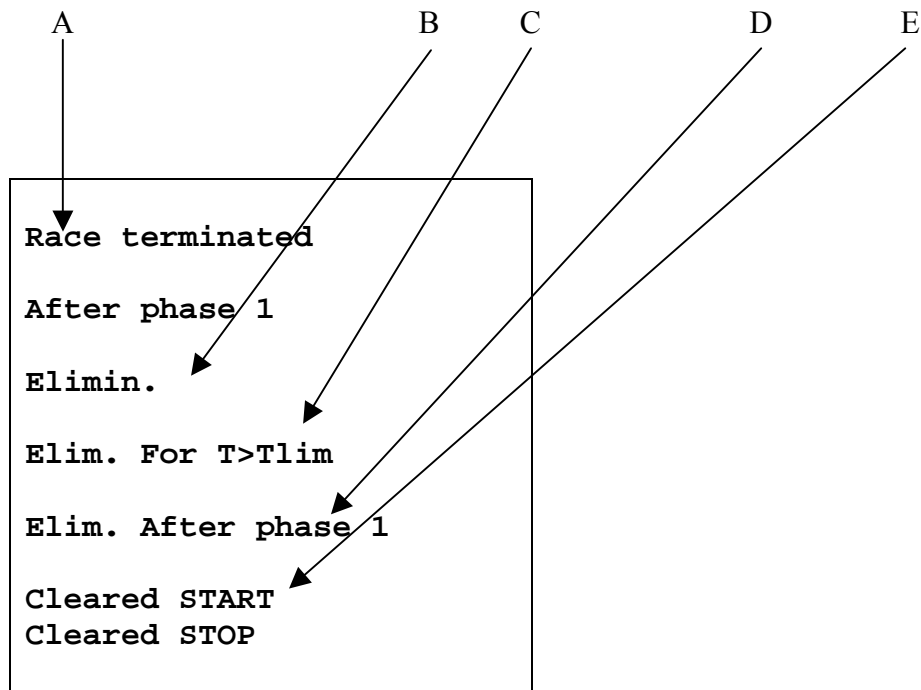

Figure 11 – printed strip: indications

- A: The race is terminated after phase one because of penalties. This printout appears in races over more than one phase if the competitor does not take part in the next phase because of penalties incurred in the first phase.
- B: Elimination
- C: Elimination because the maximum time set has been exceeded.
- C: Elimination after phase 1 because penalties have been incurred or the time has been exceeded.
- D: Annulment of an event.

4.12.2 Printing of results

After the end of the race has been confirmed, a table summarising the race is printed.

Let's have a detailed look:

| Final result | |
|--------------|--------|
| Act.T. | 69.21s |
| Act.T.1 | 69.21s |
| T.Corr. | 6.00s |
| Tot.T. | 75.21s |
| T>Tmax | 4.00p |
| Penalty | 7.00p |
| Total | 11.00p |

Figure 12 – printed strip with results

A. Printout title

B: Type of event acquired. This can have one of the following values:

- **Act.T** actual time of the phase in progress
- **Act.T.1** actual time of phase 1 in races with more than one phase
- **T.Corr.** penalty as time correction
- **Tot. T.** total race time (actual time + penalty as time correction)
- **T>Tmax** penalty for exceeding maximum time
- **Penalty** penalty in points
- **Total** total penalty points (for exceeding maximum time + points penalty)
- **Interr.** value of time count at the moment of an interruption.

Note: Calculation of the penalty for exceeding maximum time has been carried out with a setting of **1 point** for every **4 seconds** begun after the **Tmax** of **60 seconds**.

During the timing session other information notes may be printed.

5 Group management

It is possible to define up to a maximum of 199 groups, each subdivided into 20 subgroups. The groups are used for the calculation of position in the ranking during timing, for the printing of rankings and for the calculation of the starting order of subsequent runs.

The same athlete can be inserted into any number of groups. The group numbers do not have to be consecutive but can be assigned as desired.

All group management is contained in the menu M 1 B → **Input/Printout groups** and the following instructions refer to this menu.

5.1 Input/Modify groups

This function allows you to specify the composition of the single groups.

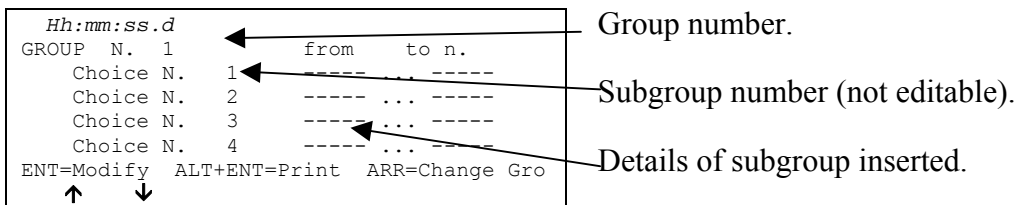

Options available:

- **<F1>** ↑ to scroll the list of the 20 choices available in each group towards choice N° 1. The choice selected is indicated by the symbol ▶ next to it
- **<F2>** ↓ to scroll the list towards choice N° 20
- **<F3>** **Clear** to delete the content of the choice indicated by the symbol ▶
- **<F4>** **Group N.** allows you to specify the group number (from 1 to 199) on which you intend to operate
- **<F5>** **quit** to quit the function
- **<ENT>** allows you to edit the values of the choice indicated
- **<ALT+ENT>** **Print** to print the composition of the groups
- **<Arrow up >** increases the group number
- **<Arrow down >** decreases the group number.

For example, suppose we want to define the following groups (categories):

| | |
|----------|---|
| Group 1 | numbers from 1 to 10 number 15 numbers from 20 to28 |
| Gruppo 2 | not used |
| Gruppo 3 | numbers from 40 to 50 |

When we have entered the function 'Insertion/editing of groups', we will then have to press the following sequence of keys:

- **<ENT>** to activate the editing mode for the first choice in group 1. The cursor moves to the column **From N.**
- **<1>** **<ENT>** for the number of the initial group member
- **<1>** **<0>** **<ENT>** to set the number of the last group member. The cursor appears next to **Choice N° 2** in the same group

- <ENT> to enable editing of choice 2 in the first group
- <1> <5> <ENT> <1> <5> <ENT> N° 15 is a member of group 1
- <ENT>
- <2> <0> <ENT> <2> <8> <ENT> to insert the numbers from 20 to 28
- <Arrow up > to set group 2 (which in this case is not used)
- <Arrow up > to set group N° 3
- <ENT> to activate editing of the first choice in group 3
- <4> <0> <ENT> <5> <0> <ENT> members of group 3
- <ESC> to quit group insertion.

To call up a group number, after accessing the function 'Insertion/editing of groups', scroll the various groups with <Arrow up > / <Arrow down > or select it directly with <F4> **Group N.** and insert the number when you are told **Insert number N.=** , then confirm with <ENT>.

REI2 repropose the various values inserted in the different choices, allowing you to change their content or to make new insertions.

To delete a group, just delete the various choices by pressing the key <F3> **Clear** after selecting them. REI2 keeps the choices from 1 upwards in consecutive order, moving any choices with a higher number down to replace the deleted choice.

5.2 *Print groups structure*

You can print the groups from the group management menu by pressing the <F2> key for **Print groups structure**. The various groups inserted will be printed on the printout together with their composition.

5.3 *Clear groups structure*

To delete completely the composition of all the groups inserted, stay in the group management menu and press the <F3> key for **Clear groups structure**. To confirm the decision to delete, press <F4> for **Yes**, otherwise annul deletion with <F5> for **No**. When deletion has been confirmed, for a few moments the message '**Groups structure cleared**' appears on the penultimate line of the display.

5.4 *Groups structure:*

This function is used to specify the number of groups and relative choices you intend to use. The product of the group and choices cannot exceed 4000 (e.g. 100 groups times 40 choices = 4000).

After accessing the function, enter the number of groups required (from 1 to 999), confirming with <ENT> and enter the number of choices for each group (from 1 to 999) again confirming with <ENT>.

Modification of the structure deletes the data for the composition of groups so REI2 requests confirmation of the operation with the message **Attention all groups will be deleted!! – Are you sure?** Press <F4> **Yes** to confirm modification or <F5> **No** to annul the operation.

5.5 *Uploading group structure from PC*

This function allows you to upload the structure of groups generated by the Microgate REI2 Uploader ©, Microrun © or MicroLink ©. Press key <F4> for **Upload group structure from PC**. On the second line of the display the message '**Ready to upload.....**' appears and you have 20 seconds to start data transmission on the PC.

If no data is received in this period the message '**Time Out Serial Upload.... Press a key**' appears. Press a key to continue. Press <ENT> to return to the group management menu.

After uploading has been activated it is possible to interrupt it before time out by pressing the <F2> key for **Interrupt** and the <ENT> key again when the message '**Upload interrupted**' appears.

During correct uploading, the data is rapidly listed on the screen. When uploading is completed, the message '**End of upload. Press a key.....**' appears. Press <ENT> to return to the menu.

Detailed information about the data structure sent from PC to REI is given in the section 25 REI2 – PC communication protocols on p.89.

For connection modes between REI2 and PC, consult the User Manual.

6 Rankings and other printouts

This menu contains the various printing options offered by REI2. Some printouts can be both consulted on the display and printed.

All print management is included in the menu M 1 C → **Rankings and other printouts** and the following instructions refer to this menu.

6.1 Print/Show ranking

This function offers a wide range of choice for the data to be shown on the display or the ranking printout.

The following options are always available:

- <ESC> to quit this choice
- <ENT> to show the list on the display
- <ALT>+<ENT> to print the selected ranking.
- <F3> Run, to set the run number to refer to
- <F4> Group, to select the group whose ranking is required (0 for all the athletes inserted)
- <F5> If enabled, also the competitors eliminated in the previous runs are added on at the bottom of the ranking.

Each time the <F1> **Ranking** key is pressed, a different ranking type is proposed.

The functioning of the <F2> and <F5> keys changes according to the choice made with <F1>. The following table summarises the various combinations possible:

| <F1> value | <F2> options | Notes. |
|---------------|--------------|--|
| Stop Times | Phase 1 | Ranking calculated on the result of the first and only phase. |
| Stop Times | Phase 1 | List of results for the first or only phase. The order is the one in which the competitors crossed the finish. |
| Stop Times | Phase 2 | Ranking calculated on the result of the second phase. The competitors eliminated in the first phase are added to the end of the ranking. |
| Stop sequence | Phase 2 | List of results for the second phase. The order is the one in which the competitors crossed the finish. The competitors eliminated in the first phase are added to the end of the ranking. |

If you decide to consult the ranking on the display, you can scroll the whole list or search for a specific competitor number at a specific position in the ranking.

The following can appear next to the competitor number:

- Mxx indicating the number of the last run in which the competitor took part (useful for checking in which run the competitor was eliminated if the option <F5> is enabled)
- Ph1 if the competitor was eliminated in phase 1.
- EL if he/she was eliminated .

Options available:

- <ESC> to return to the choice of time limits
- <F1> to scroll one event back on the list
- <F1> when pressed for over 2 seconds, scrolls quickly back up the list
- <F2> to scroll one event down
- <F2> when pressed for over 2 seconds, scrolls quickly down
- <F3> allows you to specify the competitor whose position you want to find
- <F4> allows you to specify the position for which you want to find the competitor, for example, to look for the 15th in the ranking
- <F5> to return to the previous menu.

6.2 Other printouts

6.2.1 Time of day

A complete record of time events can be consulted on the display or printed, or printing can be limited to the period between two times of day chosen by the user.

Options available:

- <ESC> to quit this choice
- <ENT> to show the list on the display
- <ALT>+<ENT> to print the time events
- <F1> allows you to change any initial value
- <F2> allows you to change any final value
- <F3> reduces to zero the initial and final values
- <F5> returns you to the menu.

If you decide to consult the time events on the display, you have the possibility of scrolling the entire time event list or extracting a part of it by setting the competitor number and/or run. It is also possible to print a single time event line.

Options available:

- <ESC> to return to the choice of time limits
- <F1> to scroll one event back on the list
- <F1> when pressed for over 2 seconds, scrolls quickly back up the list
- <F2> to scroll one event down
- <F2> when pressed for over 2 seconds, scrolls quickly down
- <F3> allows you to specify the competitor whose times you want displayed
- <F4> allows you to specify the relative run
- <F5> to print the time event indicated by the symbol ◀

6.2.2 Started in run

It is possible to find out the number of starters in each run by inserting the run number with this function.

When you press key <F4> the cursor appears next to the indication **Started in run are**. When you have inserted the run number and confirmed with <ENT>, the number of starters appears to the right of the indication **are**.

6.2.3 Eliminated Printout

When you access this function, the list of competitors eliminated in the run is printed.

6.3 *Printout and visualization mode*

This function allows you to set a few preferences concerning what you wish to print.

The options available are:

- <F1> **Data visualization:** each press alternates between **Complete** and **Selection**. If the choice **Selection** is activated, only the times considered for the ranking calculation are shown on the display. If the choice **Complete** is activated, also those times which are of no significance for the ranking displayed are presented.
- <F2> **Print gap:** each press alternates between **Disabled** and **Enabled**. If enabled, the time lag from the first athlete in the rankings is printed
- <F3> **Sort same time:** each time this is pressed, it varies between **Start order** and **Start order reversed**. In the first case, that is, according to start order, if two or more competitors have the same time, the one who started first wins (e.g. Nordic skiing); in the second case, the one who started later wins (e.g. Alpine skiing). So calculation is not based on the competitor number but on the start time. The competitor number is only considered if two or more competitors started at the same moment.
- <F4> **Send printout on serial:** each pressing of the key changes the serial port on which to send a copy of the printed data. The possible alternatives are **NOTHING**, **SERIAL A**, **SERIAL B**, **ALL**. The data are printed in the same format in which they are sent. Empty lines are not always sent.

(other...)

- <F1> **Take previous laps:** this function is suitable for relay races or for races in which the competitors run a number of laps. If enabled, also those athletes who have not completed the full number of laps appear in the rankings on paper and the displayboards with the number of laps they are behind also indicated.
- <F2> **Max athletes in rank:** allows you to set the maximum number of competitors who must appear in the ranking. To include all the competitors, set **0**.
- <F3> **Printing of competitors names:** each press alternates between **Disabled** and **Enabled**. If enabled, the competitor's name is printed in the rankings.
- <F4> **Printing of compet nations:** each press alternates between **Disabled** and **Enabled**. If enabled, the competitor's nation is printed in the rankings.

7 Departure manager

REI2 features various functions for the management of start lists. Up to 4 start lists for the same number of runs can be memorised at the same time. Every list must be uploaded from PC or calculated by REI2 on the basis of a sequence of automatic starts. Once a list has been used, it can be deleted and the space freed re-used to memorise a new list for a subsequent run. The calculation system of the start lists offers a high level of flexibility for the construction of lists in the most varied ways.

7.1 Input start list

This function allows you to manually insert a starting order.

When you have activated the function, the lists available and their characteristics are shown.

You have the following columns:

- In the first the progressive number of the list appears (from list 1 to list 4)
- **STATUS** in this column you are told if the list is **in use** or is **empty** according to whether or not it contains data
- **RUN** shows the run number the list refers to (eg: **S 2** start list for run 2)
- **N.RECORD** number of competitors in the list.

The enabled function keys are:

- <F1> ↑: to scroll the list up
- <F2> ↓: to scroll the list down
- <F3> **Delete** to delete the list shown by the symbol ◀. You are asked for confirmation of your intention to delete the list, <F4> to delete, <F5> to annul deletion.
- <F4> **Delete.All** to delete all the lists present. You are asked for confirmation of your intention to delete the list, <F4> to delete, <F5> to annul deletion.
- <F5> to return to the previous menu.

When you have selected the list to be compiled, indicating it with the symbol ◀, press the <ENT> key. If the run number is already present in the **Run** column, you enter editing of the run indicated, otherwise you are asked for the run number which should be confirmed with the <ENT> key.

Now the start list can be inserted.

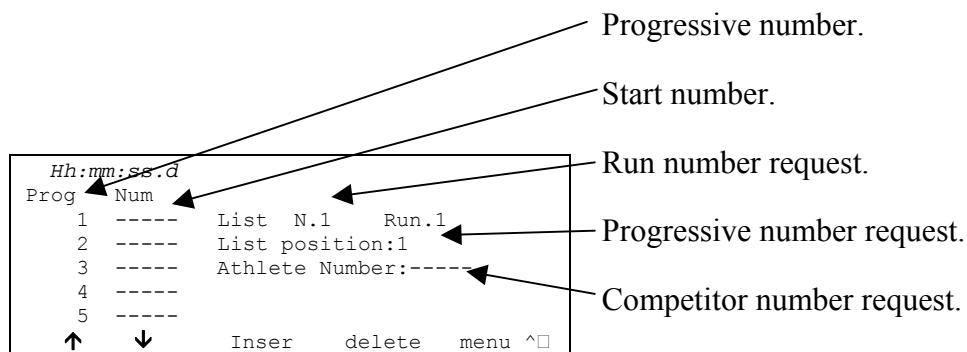

To insert a sequence of numbers you only need to key them in and confirm then with <ENT>. The progressive number automatically moves up. If necessary, it is possible to change a number by placing the cursor next to the relative progressive number, keying in the new number and confirming it with <ENT>. For corrections the progressive number does not automatically move up.

The enabled function keys are:

- <F1> ↑: to scroll the list up
- <F2> ↓: to scroll the list down
- <F3> **Inser** inserts a new line before the progressive number indicated by the cursor and prepares itself for the insertion of a new number
- <F5> **Menu** to return to the previous menu
- <ALT><F1> **Del.last** to delete the last number inserted
- <ALT><F3> **Auto Inser** With this function, a progressive sequence of numbers can be inserted. You are asked for the progressive number from which to start (it must be the first free progressive number), the progressive number to go up to and the competitor number from which to begin assignment.
- <ALT><F4> **Search** allows you to rapidly look for a value in a list. There are various search modes:
 - <F2> **Prog.** to place the cursor next to the progressive start number indicated
 - <F3> **Bib.N.** to place the cursor near to the competitor number inserted
 - <F4> **LastProg.** to place the cursor near the last progressive number
 - <F5> **QUIT** to quit the search function
- <ALT><F5> **Run** allows you to change the run number to which the list you are preparing refers
- <Arrow up> like <F1>
- <Arrow down> like <F2>.



In the case of automatic insertion starting from an already used progressive number, all the numbers already present are replaced with the new numbers calculated. No check is made for double insertion of numbers. The progressive numbers must be

contiguous.

For example: suppose we want to insert the following start order: 5,1,4,2,3,6,7,8,9,10. We enter **Input start list**, we delete all the lists with <F4> **Delete.All** and relative confirmation (<F4>), we select list 1 and press <ENT>.

The run number is requested, we insert <1> and press <ENT>. At this point we insert the numbers one after the other <5> <ENT> <1> <ENT> <4> <ENT> <2> <ENT> <3> <ENT>. Now we can insert the numbers from 6 to 10 in sequence. We press <ALT> and <F5> together. The request for the progressive number from which to start appears. If REI2 does not propose 6, we insert it (<6>) and press <ENT>, we insert the final progressive number <1> <0> <ENT> and we insert the competitor number <6> <ENT>. If we now scroll the list, we find our competitors ready to start.

7.2 Start order calculation

This function allows you to calculate a new start list. The list can be calculated using the ranking of a single run or the ranking based on the total times of the previous runs. The list thus obtained can be used as the start list of a chosen run.

The figure below shows the data request display.

The screenshot shows a terminal window with the following text:

```

Hh:mm:ss.d Start order for:
A:Run 1
B:Based on Ranking of phase xxx
C:Referring to Run 1
D:Group (0=every number)..0
E:Extract first (0=All) 15
   ESC=quit      ENT=execute
  A      B      C      D      E

```

Arrows point from the following text to the corresponding fields in the screenshot:

- Run number whose starting order must be calculated. (points to '1' in line A)
- Basis for calculation. (points to 'phase xxx' in line B)
- Run on whose ranking the calculation must be made. (points to '1' in line C)
- Group to process. (points to '0' in line D)
- Number of competitors to be extracted (points to '15' in line E)

The enabled function keys are:

- **<F1> Run** Pressing this key allows you to change the run number whose start order is to be calculated
- **<F2> On the basis of ranking** Each time this key is pressed, one of the two phases, **Ph 1** or **Ph. 2**, is proposed
- **<F3> Based on Ranking of** Pressing this key allows you to change the run to be used for the calculation based on the run times or to set the last run number to be used for the calculation based on total times up to that run
- **<F4> Group (0=every number)** Pressing this key allows you to select the group on which to carry out the list calculation. With 0 the calculation is made on all the competitors
 - **<F5> Extract first:** With this key it is possible to vary the number of competitors, those occupying the first places, which is to be copied. If the function 'Consider 1° if he/she has 0 points' is active, all those in the first places (i.e. the competitors with the lowest penalty) can be extracted by keying in the number 1
- **<ESC> ESC=quit** to quit the function
- **<ENT> ENT=execute** to make the calculation.

When you have set the correct values by pressing **<ENT>**, the list is calculated. When processing has finished, the message **'DONE!!!'** appears for an instant and the function keys are activated.

- **<F1> Print list** To print the list just calculated, return to list calculation.
- **<F2> Other list** to return to the previous function and calculate a new start list or add to one just calculated.
- **<F5> menu** to quit the start list calculation function

If there already exists a start list for the run selected, the warning: **'ATTENTION!!! Start list already exists for run number..'** appears and the function keys are activated.

- **<F1> Append the new list** to add the part of the list just calculated to the end of the list already present
- **<F2> Delete the list in the memory** to delete the part of the list already present, possibly after confirmation with the **<F4>** key, and replace it with the one just calculated.

If there are already 4 start lists in the memory, the warning **'ATTENTION!!! No list available. Proceede deleting one list'** appears and after a few seconds the list deletion function is activated. For details see section 11.3.3 Delete start lists on p.56

For example (list memory empty):

In the second run, the competitors of group 2 will start first, with extraction of the first 9, and will be followed by the competitors of group 1, with extraction of the first 6. After activating the function '**Start order calculation**' we proceed in the following way:

- <F1><2><ENT> to set the calculation of the second run
- <F3><1><ENT> to set the calculation of the first run (if this has not already been done)
- <F4><2><ENT> to operate on the second group
- <F5><9><ENT> to set the extraction of the first 9
- <ENT> to make the calculation
- <F2> for another list
- The run data, ranking and run basis are already correct and do not need to be changed.
- <F4><1><ENT> to set group one
- <F5><6><ENT> the first 6 are extracted
- <ENT> to process
- <F1> to add on to the end of the previously processed list
- If necessary, <F1> to print the list
- <ESC> to quit the function.

Note how it is possible to calculate start lists even before the runs immediately before are finished. For example, it is possible to calculate the start of the 5th run, based on the results of the 3rd, before carrying out run 4.

7.3 *Print start lists*

With this option a previously inserted start list can be printed.

When you have activated the function, the lists available and their characteristics are shown.

You have the following columns:

- In the first the progressive number of the list appears (from list 1 to list 4)
- **RUN** shows the run number the list refers to (eg: **S 2** start list for run 2)
- **N.RECORD** number of competitors in the list.

The enabled function keys are:

- <F1> ↑: to scroll the list up
- <F2> ↓: to scroll the list down
- <F3> **Print** to print the list indicated by the symbol ◀ .
- <F5> to return to the previous menu.

8 Synchronization

REI2 can be synchronized by means of the keyboard, the external line or via radio with the LinkGate system. If necessary, synchronization can be corrected by putting the internal clock forward or back.

8.1 Synchronization

Through this function, REI2's internal clock is synchronized. The operation is performed by inserting the time of synchronization, confirming each field (hour, minutes,) with the <ENT> key and then the date.

Attention: to be able to carry out synchronization the start line must be 'at rest' when <F4> is pressed (open for line N/O, closed for line N/C). If the line is not 'at rest', the message '!!!ATTENTION !!!! START line can't provide a synchronization impulse.....' will appear.

With

- <F2> the inserted data can be edited if a mistake has been made
- <F4> to confirm synchronization data. With the next start impulse, the internal clock starts
- <F5> returns you to the previous menu.

8.2 Editing synchronization value

In certain situations it may be necessary to change the synchronization of REI2 to align it with other devices which cannot be resynchronized. After establishing the gap in synchronization between the two devices (for example with a stop in parallel), insert the value as 'Time change' (paying attention to the alignment; for example, 3 hundredths should be inserted as 3000 ten-thousandths). The date can also be changed. Each value should be confirmed with <ENT>.

The enabled function keys are:

- <F1> **Time +** to change the sign of variation; with each press it enables the increase or reduction of values
- <F3> **Correct** to change any incorrectly inserted data
- <F4> **OK** to carry out correction of synchronization
- <F5> **menu** to quit the function

8.3 Synchronization verify

Calling up this function makes REI2 ready to receive an impulse from a line (main or LinkPod) or the LinkGate system

The message **SYNCHRONIZATION VERIFY – Wait for impulse...** appears on the display. When REI2 receives an impulse, the channel the impulse comes from and the date and time when it was acquired are printed on the printed strip.

8.4 Signal

With this function a synchronization impulse for the synchronization of other devices can be generated. When the function is activated, a request is made for the time and date for generation of the impulse. Every value must be confirmed with <ENT>.

The signal is generated by switching pin 6 of the I/O digital port to level 0.

9 Eliminations

This function is used to insert any eliminated athletes and to put previously eliminated athletes back into the race. When you enter the function, you are asked for the race number and the run to which the elimination refers. When you have inserted the data requested, it is possible to see the competitor's current status by pressing <ENT>.

The enabled function keys are:

- <F1> **Edit** Each time you press the key, the competitor passes from **Qualified** to **Eliminated** status.
- <F3> **Other** to insert the number and run of another competitor
- <F5> **menu** to quit the function

10 Download data to to PC

When a competition is in progress or at its end the transmission of data to the electronic processors may be requested without the processor itself requesting this. The port to use and the transmission velocity can be specified with the function Serial ports setup (see chap. 12.3 on p.64).

There are two data transmission modes,; ‘Off-Line’ and ‘On-Line’.

The data which can be sent are:

- **Time of day:** all the events recorded
- **T Total:** total times
- **T Run:** the times of individual runs
- **T Lap:** intermediate times
- **NS, DNF, Elim:** all the competitors not in the competition such as non-starters, non-finishers and eliminated competitors (only off-line)
- **Skipped:** all skipped events (cannot be activated in this version)
- **Speeds:** calculated speeds, both average and instant time (cannot be activated in this version).



The times actually obtained are transmitted and penalties incurred are not taken into account. The calculation of the total time, based on the time actually taken to complete the course plus penalties assigned in points or as time correction, is referred to the program which acquires the data.

The main competition data (total times, penalties,...) is however transmitted both On-Line and Off-Line.

10.1 Off-Line data transmission

With this function it is possible to select the data to be sent to the PC and to begin its transmission. The data indicated with **On** will be sent to the PC through the specified serial port. It is possible, if required, to specify the run and/or group of competitors whose data is to be sent (the value **0** indicates all).

The enabled function keys are:

- **<F1> ↑**: to move the cursor up
- **<F2> ↓**: to move the cursor down
- **<F3> Edit:** allows you to change the **Run** or **Group** number or to select (**On**) / deselect (**Off**) the data type, indicated by the arrow (**→**), to be transmitted
- **<F5>** to return to the previous menu.

During transmission the message ‘**Transmission.....in progress**’ appears on the display and for each type of data requested, the type and number of records transmitted.

10.2 On Line data output setup

This function allows you to specify the data to be sent to the processor at the instant in which REI2 stores them in its memory. Some of these, such as the start (in standard setting) are immediately stored and then transmitted. Others, like the stop, must be confirmed by the operator and are then sent only after the user has given confirmation.

The enabled function keys are:

- <F1> ↑: to move the cursor up
- <F2> ↓: to move the cursor down
- <F3> **Edit**: allows you to select (**On**) / deselect (**Off**) the data type, indicated by the arrow (→), to be transmitted
- <F5> to return to the previous menu.

On-Line data transmission can be activated and deactivated as you desire while a competition is in progress. You should keep in mind, however, that REI2 does not transmit events and values calculated on-line while transmission was deactivated.

10.3 Data output protocol

Allows you to choose which protocol to use for data transmission to the PC. Each time it is selected, one of the possibilities is activated. These are:

- '**Microgate**': All the potential of the stopwatch is used
- '**Alge 4000**': The data is transmitted using the protocol Alge 4000. The choice of data transmittable with this protocol (see chap. 10.1 Off-Line data transmission on p.52 and 10.2 On Line data output setup on p.52) is limited to only net times.

Because it is more complete and more flexible, we advise you to use the Microgate protocol and to use the Alge protocol only if there are counting problems with the software used for data processing.

Serial transmission velocity is automatically set at 2400 for both the serial ports (see chap. 12.3 Serial ports setup on p.64).

11 Upload data from PC

11.1 Upload data from PC

11.1.1 Upload of competitor lists from PC

This function allows you to upload the list of competitors generated by the Microgate Uploader ©, Microrun © or MicroLink ©. Press key <F1> for **Upload data from PC** and <F1> again for **Upload** competitor list from PC. On the second line of the display the message '**Ready to receive.....**' appears and you have 20 seconds to start data transmission on the PC.

If no data is received in this period, the message '**Serial communication Time Out Press any key**' appears. Press a key to continue. Press <ENT> to return to the list management menu.

After upload has been activated it is possible to interrupt it before time out by pressing the <F2> key for **Break** and the <ENT> key again when the message '**Reception interrupted**' appears.

During correct upload, the data is rapidly listed on the screen. When upload is completed, the message '**End of upload. Press a key.....**' appears. Press <ENT> to return to the menu.

However, REI2 can receive the competitor list in background without the need to access this menu.

However, REI2 can receive start orders in background without the need to access this menu.

Detailed information about the data structure sent from PC to REI is given in chap. 25 REI2 – PC communication protocols on p.89.

For connection modes between REI2 and PC, consult the User Manual.

11.1.2 Upload groups structure from PC

This function is the same function present in the menu Insertion/Printing of groups –Upload of structure from PC. Consult chap. 5.5 Uploading group structure from PC on p.40.

11.1.3 Upload start lists from PC

This function allows you to upload the start orders generated by the Microgate REI2 Uploader ©, Microrun © or MicroLink © programs. Press the key <F1> for **Upload data from PC**, key <F3> for **Upload start lists from PC**. On the second line of the display the message '**Ready to receive.....**' appears and you have 20 seconds to start data transmission on the PC.

If no data is received in this period, the message '**Serial communication Time Out Press any key**' appears. Press a key to continue. Press <ENT> to return to the group management menu.

After upload has been activated it is possible to interrupt it before time out by pressing the <F2> key for **Break** and the <ENT> key again when the message '**Reception interrupted**' appears.

During correct upload, the data is rapidly listed on the screen. When upload is completed, the message '**End of upload. Press a key.....**' appears. Press <ENT> to return to the menu.

Detailed information about the data structure sent from PC to REI is given in chap. 25 REI2 – PC communication protocols on p.89.

For connection modes between REI2 and PC, consult the User Manual.

11.1.4 Printouts lists

Consult the function described in 7.3 Print start lists (on p.48).

11.1.5 Delete lists menu

With this option it is possible to delete a previously calculated or uploaded start list, or all the lists present en bloc.

When the function has been activated, the lists available and their characteristic data appear on the display.

You have the following columns:

- In the first column the progressive number of the list appears (from list 1 to list 4).
- **STATUS:** this column indicates whether the list is **in use** or is **empty**, depending on whether or not it contains data
- **RUN** shows the run number the list refers to (e.g. **S 2** start list for run 2)
- **N.RECORD** the number of competitors in the list

The enabled function keys are as follows:

- **<F1> ↑**: to scroll up the list
- **<F2> ↓**: to scroll down the list
- **<F3> Delete** to delete the list indicated by the symbol ◀ . You are requested to confirm whether you intend to delete the list, **<F4>** to delete, **<F5>** to annul deletion.
- **<F4> Canc.All** to delete all the lists present. You are requested to confirm whether you intend to delete the list, **<F4>** to delete, **<F5>** to annul deletion.
- **<F5>** to return to the previous menu.

11.2 Printout lists

Selection of this function allows you to print various lists.

The enabled function keys are:

- **<F1> Print competitors list** to print the list of those who have entered for the competition. On the printout the competitor number, nation and name are indicated
- **<F2> Print group structure** On the printout the various groups entered and their composition are printed
- **<F3> Print start list** Similar to the function described in chap. 7.3 Print start lists on p.48
- **<F5> menu** to quit the function

11.3 Delete lists menu

This function allows you to delete the various lists in REI2's memory.

11.3.1 Delete competitor name lists

This function allows you to delete the list of competitors' names. To confirm the decision to delete, press **<F4>** for **Yes**, otherwise annul deletion with **<F5>** for **No**. When confirmation of the decision

to delete has been given, the message **‘Competitors’ names deleted!’** appears for a few moments on the penultimate line of the display.

11.3.2 Delete groups structure

This function allows you to delete the structure of the various groups inserted. To confirm the decision to delete, press <F4> for **Yes**, otherwise annul deletion with <F5> for **No**. When confirmation of the decision to delete has been given, the message **‘Group deletion done!’** appears for a few moments on the penultimate line of the display.

11.3.3 Delete start lists

Similar to the function described in chap. 11.1.5 Delete lists menu on p.55

12 REI2 setup

The various configuration menus allow you to modify the numerous settings that affect the way REI2 functions. When you decide to delete the configuration at the start of a new race or select Modify basic configuration (see relative section 22 on p.86) and select the configuration most suitable for the timing session, all the parameters will be set to those values most suitable in the greatest number of cases.

12.1 Software setup

This menu contains the settings which guide the functioning of the program.

12.1.1 Phases

Each selection presents one of the four alternative types of race managed. The presence or absence of particular items of software configuration depend on this choice.

The possible choices are:

- **Ph.: Single**
- **Ph.:2,Single score:** two phases with progressive time. During phase 2 running time continues from the time of phase 1.
- **Ph:2,Two scores:** two phases with separate times. The time of phase 2 restarts from 0.
- **Ph:Barrage cons.:** Consecutive barrage. There is a pause at the end of the first phase (see chap.12.1.10 Phase 1-phase 2 on p.59) after which a second countdown begins for phase 2.

12.1.2 Penalty settings

Allows you to set the values for penalties in points and as time correction associated with the function keys.

After you have accessed the function, the indication **Values Penalty** appears on the penultimate line of the display. To change the value of the penalty associated with the function keys, from F1 to F3, press on them. The cursor appears on the value to be changed. When you have inserted the required value, press <ENT> to confirm.

To change the value associated with 'time correction', press the key <F4> for **P/T.C.:**. On the penultimate line the indication changes to **Values T.Corr.** Then operate as described in the previous paragraph.

The enabled function keys are:

- <F1> , <F2> e <F3>: these must be pressed to change the values associated with them
- <F4> **P/T.C.:** passes from the editing of the values of points to the editing of the values of time corrections.
- <F5> **quit** to quit the function.

12.1.3 Table Ph1/sing.

Allows you to select the FISE table to be used during the first/single phase. Each time the key <F3> is pressed, one of the three alternatives - **A** for FISE table A and **C** for FISE table C - or **Points**

| | | |
|---|------------------------------|--|
|  | REI2 Show Jumping Program | Doc: R2U_E_1079_002_E Version: 1.07.9 Page 58 of 103 |
|---|------------------------------|--|

Race is activated. On the last line of the display REI2 communicates the change made with the message **ATTENTION: Points changed!**

If **Points Race** is activated, REI2 displays points instead of penalties (the indications on the stopwatch and displayboards are modified: pen -> pts).

For single phase only it is possible to select the total of the previous runs. Each time the key <F4> is pressed, one of the two alternatives **No** or **Yes** is activated.

12.1.4 Table Phase 2

Allows you to select the FISE table to be used during the second phase. Each time the key <F4> is pressed, one of the two alternatives - **A** for FISE table A and **C** for FISE table C – is activated. This configuration setting is not available in single phase.

12.1.5 Maximum time penalty - phase1/single phase

Setting of the penalty to be applied, if the preset maximum time is exceeded, for each second begun in the first or only phase.

The penalty can be set to 0 (zero).

12.1.6 Maximum time penalty - phase 2

Setting of the penalty to be applied, if the preset maximum time is exceeded, for each second begun in the second phase. The setting is not available if the mode chosen is single phase.

The penalty can be set to 0 (zero).

12.1.7 Add previous runs

With this option (of default **No**) it is possible to add on the result of the previous run. When the function key <F4> is pressed, REI2 proposes in sequence **At begin**, **At the end** or returns to **No**. If **At begin** is selected, at the **Start** of the competitor in the second run on the display and displayboard, it shows the result of the previous run. It will then continue with the race time and penalties in the second run already added on. If **At the end** is selected, it shows the time of the second run starting from zero and the total of the two times and the penalties will be made at the end of the race. This option has been designed for category N° 12 in the FISE regulations.

12.1.8 Take delay after countdown

With this function it is possible to specify if any delay accumulated after the initial countdown must be penalized.

Each time the key <F3> is pressed, one of the two alternatives – **Yes**, the counting of race time continues from the positive countdown value, **No**, the count always starts from zero – is activated. In this case, when countdown is over the displayboard remains at 0 time.

12.1.9 Ranking based on

In races with two separate phases, it is possible to choose which net time to use for calculation of the ranking. There are three possibilities: second phase, first phase or the total of the two phases.

12.1.10 Phase 1-phase 2 pause

By accessing this function it is possible to specify the time which passes between the end of the first phase and the beginning of the countdown of the second phase.

When the key <F4> for **Pause Ph 1 2** is pressed, the cursor places itself on the value to be changed. After inserting the required value, from 0 to 998, press <ENT> to confirm. If the value 999 is entered, the pause between the first and second phase is set at **15** seconds and finishes when this expires. After this, the stopwatch stops until there is LAP impulse to start the second countdown or reception of a LAP impulse.

If instead any value other than 999 (for example 15) is set, the pause between the first and second phase is set at **15** seconds and finishes when this expires. After this, the stopwatch automatically begins the second countdown or waits for the reception of a LAP impulse from the jury's button.

This configuration value is requested only for consecutive barrage.

12.1.11 Finish signals

This function allows you to assign the various events to the logical channel on which they will be acquired so as to adapt REI2 to the different configurations of the course and, of course, to the race type. Some examples are shown in chap. 28 Course types on p.100 (appendix A).

The enabled function keys are:

- <F1> **End of run:** Each time the key is pressed, one of the two alternatives, **START** and **STOP**, is proposed
- <F2> **End of Ph. 1:** Each time the key is pressed, one of the three alternatives, **START**, **STOP** and **AUX** is proposed. This function is not available for single phase
- <F3> **Start of Ph. 2:** Each time the key is pressed, one of the four alternatives, **START**, **STOP**, **LAP2** and **AUX** is proposed. This function is not available for consecutive barrage.
- **Note:** This set-up phase is particularly important. REI2 follows this logical sequence of settings to accept the event to be used and must correspond to the settings of the Encoder Linkgate ® placed at the various 'finish lines' in the arena. Anomalous signals are discarded.

12.1.12 Start time

Specifies the value, in seconds, from which the initial countdown for the first or single phase must start. The values allowed range from zero to 999. If this value is set at zero, there is no countdown before the start and the competitor is free to start when he/she wants.

12.1.13 Maximum time value

Specifies the value, in seconds, of the maximum time allowed for completion of the course for the first or single phase. When this time runs out, a situation shown on the display with the indication **T>Tmax**, the extra seconds will be penalized. The values allowed range from 1 to 999. If 0 is set, the maximum time is deactivated. If the T.max is modified after some of the competitors have already started, you are asked to **Update previous data of run xx**. In this case, all the total penalties of the competitors who have started in run xx are recalculated taking this last maximum time into account.

12.1.14 Time limit value

Specifies the value, in seconds, of the time limit allowed for completion of the course for the first or single phase. The competitor who exceeds the time limit is automatically deleted, a situation shown both on the display and on the printed strip, with the indication **Elim. For T>Tlim**. The value proposed is equal to double the maximum time. The values which can be inserted manually range from the 'maximum time' to 999.

12.1.15 Delete after first phase: (2,S,C)

With this function it is possible to specify whether at the end of the first phase the competitor who has incurred points and time correction penalties must be eliminated.

Each time the key <F4> **Delete after 1st phase:** is pressed, one of the two alternatives – **Yes**, to eliminate him/her, **No** to allow him/her to take part in the next phase – is activated. This function is not available in single phase mode.

12.1.16 Phase 2 start time (2,S,C)

Specifies the value in seconds of the countdown of the second (or next) phase. The values allowed range from zero to 999. This function is not available in single phase mode and in two phases, separate or progressive time.

12.1.17 Phase 2 maximum time (2,S,C)

Specifies the value, in seconds, of the maximum time allowed for completion of the course for the second phase. When this time runs out, a situation shown on the display with the indication **T>Tmax**, the extra seconds will be penalized. The values allowed range from 1 to 999. This function is not available in single phase mode. If 0 is set, the maximum time is deactivated. If the T.max is modified after some of the competitors have already started, you are asked to **Update previous data of run xx**. In this case, all the total penalties of the competitors who have started in run xx are recalculated taking this last maximum time into account.

12.1.18 Phase 2 time limit (2,S,C)

Specifies the value, in seconds, of the time limit allowed for completion of the course for the second phase. The competitor who exceeds the time limit is automatically eliminated, a situation shown both on the display and on the printed strip, with the indication **Elim. For T>Tlim**. The value proposed is equal to double the time limit for the second phase. The values which can be inserted manually range from the 'maximum time' to 999. This function is not available in single phase mode.

12.1.19 Visualize countdown on displayboard

By pressing the key <F1> it is possible to activate/deactivate display of the countdown on the displayboard. Each time the key is pressed, one of the two alternatives is activated (**Yes** displays the countdown, **No** does not display it).

12.1.20 Print Time of day

Pressing the <F2> key allows you to activate/deactivate the printing of time events when the various events (Start, Lap, Stop) take place. When printing is deactivated, only net times are

printed. Each time you press the key, one of the two alternatives is activated (**Yes** time event printing activated, **No** printing deactivated).

12.1.21 Sound counter

Specifies whether to activate a sound signal five seconds before every significant event (e.g.: end of countdown, Tmax, Tlim, Tmax Ph1, pause Ph1/Ph2, etc....).

12.1.22 Auto lines block after every event

With this function it is possible to specify whether the different lines must automatically be 'locked' after reception of an impulse or be left active.

Each time the key <F4> <F4> **Auto lines block after every event:** is pressed, one of the two alternatives – **Yes**, the lines are locked, **No** the lines are left active – is activated.



This is particularly useful if it is presumed that by passing the various acquisition points the horse can generate unwanted impulses but the operator must intervene to re-enable the lines when the competitor approaches a required acquisition.

12.1.23 Take point for 2nd phase

With this function it is possible to specify whether the penalties assigned during the first phase should be carried over to the second phase or whether the count must restart from 0.

Each time the key <F1> **Take point for 2nd phase:** is pressed, one of the two alternatives – **Yes**, to start the penalty count from the value of the first phase, **No** to start from zero – is activated.

This function is not available in single phase mode and is significant only if Delete after first phase: (2,S,C) (see chap. 12.1.15 on p.60) is set to **No**.

12.1.24 Subtract penalty if T>Tmax

This function is only for points races.

With this function it is possible to establish whether the penalty points to be applied for exceeding the maximum time must be subtracted from the total of points obtained.

Each time the key <F2> **Sub. penalty if T>Tmax:** is pressed one of the two alternatives – **Yes**, the penalty must be subtracted (reduced), **No** the penalty is added - is activated.

In the case of a points race, the competitors are ordered on a decreasing points basis, the first being the one with the most points. When the number of points is the same, those with the lower time are ranked first. Eliminated competitors are also ranked if they have obtained points, with the ranking based only on the points obtained in decreasing order. These competitors do not have a time and are inserted after the competitors who, after finishing the course, have a race time.

12.1.25 Consider 0 points as 1st

If this function is activated, the ranking is changed according to this criteria:

- The minimum penalty is calculated (or maximum if the function **Sub. Penalty if T>Tmax** is active)

- If the competitor's penalties are the same as the minimum penalty, then he/she is considered to be first
- If the penalty of two or more competitors is the same as the minimum, the finish sequence decides the ranking (however, they are all first on the basis of performance).
- The rest of the ranking is calculated on the basis of standard criteria.

12.1.26 Time accuracy

When you select this option, you are asked for the precision of the measurement to be used for the calculation of Lap and net time. Remember that all the time events are recorded with the maximum precision (1/25000 of a second), which is also used to make calculations, whatever precision is set, unless the time event truncation function is active.

The options available are:

- <F1> each time you press this key, one of the 5 alternatives (1", 1/10, 1/100, 1/1000) is activated.
- <F2> allows you to insert the figure (first not significant) starting from which you pass to the significant unit above (e.g. with precision at 1/100 setting 4 xx.2842 becomes xx.29 while xx.2839 becomes xx.28). If you set 0, truncation is always carried out.
- <F3> activates the truncation of time events at the moment they are recorded. Each time you press the key, one of two alternatives is activated (**Yes** for truncation activated, **No** for no truncation). If truncation is activated, REI2 asks if truncation should be extended to all the time events of the race in progress and so also to those already recorded. With <F5> extension of truncation is not accepted, with <F4> irreversible truncation of all time events is accepted.

Time event truncation is useful in those races, such as the relay, in which, because of the various truncations, adding together the times of each relay runner can result in a total different from the total race time.



Truncation of chronological data is an irreversible operation. Once the intention to truncate the data in the memory has been confirmed, it is no longer possible to retrieve the truncated part. Similarly, it is no longer possible to acquire the truncated part for all the new events recorded.

12.1.27 Time display mode

When this setting is selected, two choices are available: pressing <F1> alternates the choice between SSSSS.DCMd or HH:MM:SS.DCMd.

12.1.28 Start without countdown

If set to **Yes**, REI2 considers the competitor to be regularly in the race, then it begins the time count the moment it receives a START signal, even if it has not previously received the LAP signal for start of countdown.

If set to **No**, if a START impulse is received before the LAP impulse for start of countdown, this is ignored and is communicated to the operator with a special acoustic signal.

12.1.29 Point accuracy

Allows selecting of the accuracy of the points used. Two choices are available: **Hundreds** and **Units**. If **Hundreds** is selected, the penalties which can be set range from 0 to 99,99 with an accuracy of two decimal figures. If **Units** is selected, the penalty ranges from 0 to 999 without decimals.

This setting is useful in **SHOW JUMPING** competitions where the penalties are again 0.25 points for every second begun after **Tmax** has been exceeded.

12.1.30 Add on display. T.C. at the end

If active, this allows the time correction to be displayed on the displayboard only at the end of the race, while it has already been added on the REI2 display. If disabled, the time correction is applied immediately.

12.2 Hardware setup

This menu contains the settings which guide the functioning of the stopwatch.

12.2.1 LinkGate channel

Pressing key **<F1>** opens a submenu which shows the setting the dip-switches must have on the LinkGate®Encoder for the channel previously stored. Pressing **<F2> Modify** activates the cursor next to the channel number, from 0 to 127. Key in the number you intend to use. When you have inserted the number and pressed **<ENT>**, the new setting the dip-switches must have on the LinkGate®Encoder is shown.

The first dip-switch does not affect channel selection and so is shown as **LONG** or **SHORT**.

Pressing **<F3>Length** modifies the position of the first dip-switch shown, alternately, as **LONG** or **SHORT**

The **<F5> menu** key returns you to the hardware configuration menu.

Remember that it is absolutely essential that the channel set on REI2 and on LinkGate Encoder should coincide. For further information see the User Manual.

12.2.2 Printer on

This allows you to turn the printer on/off. Each time the **<F2>** key is pressed, one of the two alternatives **On** or **Off** is activated.

12.2.3 Keys beep

This allows you to enable the emission of a beep each time a key is pressed. Each time the **<F3>** key is pressed, one of these two alternatives is activated: **Disabled**, no beep or **Enabled**, a short beep each time a key is pressed.

Beep emission always remains active and is not affected when the line keys are pressed.

12.2.4 Display contrast

This allows you to vary the contrast on the display to improve its legibility in conditions of bad light. The <F2> key allows you to reduce contrast while the <F4> key allows you to increase it. By pressing the two keys <F1> and <F4> for more than 2 seconds, you can regulate contrast more rapidly.

Remember that you can activate back-lighting of the display with the <Light> key. Be careful not to quit this function when contrast on the display is regulated in such a way that it is impossible to read it.

The <F5> **other** key takes you to Menu M 3/1/2b.

12.2.5 LinkGate transmission length

Each time the <F1> key is pressed, one of the two alternatives **L** or **S** is activated. The setting chosen must correspond to the one made on the Linkgate Encoder (see user manual for further information). With transmission duration set to **S**, signals from the same EncRadio channel can be transmitted in rapid succession.

This configuration is particularly suitable, for example, in the acquisition of intermediate times which are close together in evaluation tests during training sessions.

Key <F5> returns you to the hardware configuration menu.

12.3 Serial ports setup

REI2 has two serials with protocol RS 232 for connection to data processors. The two serials, designated **Computer A** and **Computer B**, are individually configurable both for transmission velocity and the data presented. A few velocity combinations are, however, not available.

The configurable data are **Speed** for transmission velocity, **On-Line data** for sending data as soon as an event has occurred, **Off-Line data** for sending data in response to a request by the processor and **Tick** for the sending of running time for every pre-set period.

When you enter configuration, the following function keys are activated:

- <F1> ↑ allows you to scroll up the various configurable features
- <F2> ↓ allows you to scroll the list down
- <F3> ⇄ to pass from serial A to serial B
- <F4> **edit** to change the setting indicated by ► ; each time you press, one of the values possible is activated
- <ALT>+<F2> **Tick delay** makes it possible to set the delay in ten thousandths of a second, in which form the tick is sent on the serial. Using a LinkGate system for finishes this is advisable at the minimum 200 to prevent the time displayed from running backwards, while for LinkPods 150ms is recommended.
- <F5> **menu** to return to the configuration menu.

The values which can be set are

- **Velocity** (in bps): 1200, 2400, 4800, 9600, 19200, 28800, 38400, 57600, 115200
- **On-Line data**: Yes for transmission activated , No for transmission not activated
- **Off-Line data**: Yes for transmission activated , No for transmission not activated

- **Tick:** Disab. For no transmission, 1s, 1/10 and 1/100

The values set can be changed with the appropriate commands sent by the processor REI2. For details of transmission and reception protocol, consult 25 REI2 – PC communication protocols on p.89.



Not all the combinations of Serial A and Serial B velocity are compatible. REI2 indicates this by putting a line through the speed which cannot be set (e.g.: Ser. A: 1200 Ser. B ~~115200~~).

12.4 Printout Stopwatch setup

With this function, which can be obtained by pressing the <F4> key **Printout Stopwatch setup**, you can get a complete printout of the configuration set on REI2.

13 Displayboards setup

With this menu, the type of displayboards connected to REI2 can be set and some of their operational modes specified.

13.1 Virtual scoreboard

REI2 can directly manage up to 16 strings of Microgate μ TAB displayboards (each string is formed of a master displayboard and, if required, up to three slave displayboards) or μ GRAPH displayboards. This function allows you to select their type, number and the data to be presented on each of them.

When you have entered the configuration function with the <F1> key **Virtual scoreboard**, a list is proposed in which the configuration currently set is indicated.

In the '**Addr**' column the address value to which the displayboard is to be set is indicated. Remember that the Address values of the displayboard must correspond to the value indicated in the first column.

In the '**DISP. TYPE**' column, the type of displayboard chosen is shown; a series of ---- indicates an inactive line.

In the column '**NUM.DISP**' the number of displayboards set for that address is indicated.

In the column '**VISUALIZATION**', the type of data which will be sent is shown with some abbreviations.

The active function keys are:

- <F1> \uparrow allows you to scroll the list up
- <F2> \downarrow allows you to scroll the list down
- <F3> **modify** to change the displayboard setting on the Address indicated by \blacktriangleleft
- <F5> **menu** to return to the configuration menu.

When the **Edit** function has been selected, the configuration set for the line selected is shown.

The active function keys are:

- <F1> \uparrow allows you to run through the list of configurations available in one direction which are compatible with the displayboard type and the number of elements selected
- <F2> \downarrow allows you to run through the list of configurations available in the other direction
- <F3> **Disp.type** allows you to select the type of displayboard
- <F4> **N.Elem** allows you to select the number of displayboards on the line
- <F5> **Conf.** to return to the menu, accepting the configuration currently set
- <ESC> **Quit without confirming** to return to the menu without making modifications.

While you are choosing configuration, inside some rectangles you are shown how the data will appear on the displayboard. In the table below, some of the variations currently available are listed.

| Type Tab. | Num. | Abbreviation | Description |
|------------|------|--------------------|--|
| Microtab | 1 | Race time | Running time or net time |
| Microtab | 1 | Num Race T. | Competitor number and running time |
| Microtab | 2 | Num Race T. Points | Competitor number, race time and penalties assigned |
| Microtab | 4 | 1 Num Race T. Name | Number 1 , Number, penalties, net time and name of competitor in first place |
| Microtab | 4 | 2 Num Race T. Name | As above but for second |
| Microtab | 4 | 3 Num Race T. Name | As above but for third |
| Micrograph | 1 | Pos Num Time | Medium-size characters: first line letter P , position in 3 figures, letter N , number in 5 figures; second line hours, minutes, seconds, tenths and hundredths. |
| Micrograph | 1 | Name surname Time | Medium-size characters: first line competitor name, second line race time |
| Micrograph | 2 | 1&2 N Race T. Name | Medium-size characters: on the first line number 1 , number, penalties, net time and name of competitor in first place; on the second line number 2 and the same information for the second. |
| Micrograph | 2 | 3&4 N Race T. Name | As above but for the third and fourth with the numbers 3 and 4 . |
| Micrograph | 2 | 1&2&3 N Race T. N | Small characters: on the first line number 1 , number, penalties, net time and name of competitor in first place; on the second and third line numbers 2 and 3 and the same information for the second and third. |
| Micrograph | 2 | 4&5&6 N Race T. N | As above but for the fourth, fifth and sixth with the numbers 4 , 5 and 6 . |
| Micrograph | 2 | N Race T. Penal. | Number, race time in seconds and hundredths, penalty points with large characters |

The configuration chosen previously is activated as soon as you return to Displayboard configuration.

Let's look, for example, at how to set a configuration in which we have 2 MicroTab displayboards (1 master and 1 slave) and 2 MicroGraphs on which we want to display the number, time and penalties. For instructions concerning the connection and setting up of the displayboards, consult

the MicroTab and MicroGraph manuals. (In the example displays, it is supposed that none of the displayboards have been previously configured).

After entering the function 'Virtual scoreboard', press the <F1> key until the cursor ◀ is positioned alongside the 0 in the **LINE** column, then press

```
Hh:mm:ss.d
ADDR DISP.TYPE NUM.DISP VISUALIZATION
0◀ ----- -- -----
1 ----- -- -----
2 ----- -- -----
4 ----- -- -----

↑ ↓ Modify other
```

<F3> for **Edit**

```
Hh:mm:ss.d
Displayboard=None N.Elements= 0

-> [-----]

ESC=quit without confirming
↑ ↓ Disp.type E.Elem Conf.
```

<F3> again for **Disp.type** until the message **Displayboard =Microtab** appears on the second line

```
Hh:mm:ss.d
Displayboard=Microtab N.Elements 1

[34:56.78]

Race time
ESC=quit without confirming
↑ ↓ Disp.type E.Elem Conf.
```

Press <F4> for **N.Elem** and set the number of elements for line <2> and press <ENT>

```
Hh:mm:ss.d
Displayboard=Microtab N.Elements= 2

[N123 345.67 p45.67]

Num Race T. Points
ESC=quit without confirming
↑ ↓ Disp.type E.Elem Conf.
```

Press the key <F2> until the indication 'Num Race T. Points' appears on the third line from the bottom.

```
Hh:mm:ss.d
Displayboard=Microtab N.Elements= 2

[N123 345.67 p45.67]

Num Race T. Points
ESC= quit without confirming
↑ ↓ Disp.type E.Elem Conf.
```

Confirm the setting with <F5>. You automatically return to the configuration menu.

```
Hh:mm:ss.d
ADDR DISP.TYPE NUM.DISP VISUALIZATION
0◀ Microtab 2 Num RaceT.Points
1 ----- -- -----
2 ----- -- -----
4 ----- -- -----

↑ ↓ Modify other
```

Now to set the second line press <F2> to move next to N° 1, <F3> for **Edit**, <F3> again for **Disp.type** until the indication **Micrograph**, <F4> <2> <ENT> appears on the second line to set the two elements, and <F2> until the indication **Number Time(graph) Pen.** appears on the fourth line.

```
Hh:mm:ss.d
Displayboard=Micrograph  N.Elements= 2

Number Time(graph.)  Pen.
678      56.78      56.78

ESC= quit without confirming
↑ ↓      Disp.type E.Elem  Conf.
```

Press **<F5>** to confirm the setting and to return to the configuration menu.

```
Hh:mm:ss.d
ADDR DISP.TYPE  NUM.DISP  VISUALIZATION
0   Microtab   2         Ppos Nnum RaceT
1   Micrograph 2         N RaceT Penal.
2   -----  --        -----
4   -----  --        -----

↑ ↓      Modify      other
```

Our configuration is now ready and we can quit the function with **<F5> Menu**.

13.2 Visu. pause

By pressing the **<F2>** key, it is possible, in the field with the indication **Stop**, to set the time the data of the finished competitor remains on the displayboard, and in the field with the indication **Lap**, the time the data of the competitor who has arrived at the intermediate stage remains. The times of display can be set from 1 to 60 seconds and confirmed with **<ENT>**. For the modes with which REI2 uses this item of data see Displayboard management (chap. 4.8 on p.32).

Remember that when the value of the items to be displayed has exceeded 4, the time they are shown for is halved until only 4 events are in the queue.

This value must be set at a value which enables the competitor to read the displayboard, and avoids excessive queuing.

13.3 Serial speed displayboards

With this function you can set REI2's velocity transmission to the Microgate MicroGraph displayboards. Remember that the velocity of the serial lines of the MicroGraph displayboards can be configured by the user, while that of the MicroTab displayboards is fixed at 1200 (except on special versions).

Each time you activate the **<F3>** key, one of the possible options (1200, 2400, 4800, 9600, 19200, 28800, 38400, 57600) is activated.

N.B.: The velocity set on REI2 must coincide with the velocity set on the displayboard.

13.4 Spot program

Every time selection is made the activation command and disactivation command of the 'Advertising' program are sent alternately to the displayboards. For further details, refer to the manuals for the Microgate μGRAPH and μTAB displayboards.

13.5 Visualization nation

Every time selection is made the display of the competitor's nationality is activated/disactivated. The function is relevant only if the nationality of the individual competitors has been uploaded onto REI2. (See chap. Upload of competitor lists from PC on p.50.)

13.6 Configuration line 485

Every time selection is made communication on the serial port RS485 (as well as on port RS 232) is activated/disactivated. Refer to the **user manual** for further details.

13.7 Visualize time without point

Each time selection is made the emission of the time without the point separating seconds and fractions of a second is activated/disactivated while continuing to follow the dispositions described in MTime accuracy (chap. 12.1.26, p.62). If set to **No**, the display format is SSSSS.DCMd, i.e. with the separating character ‘.’. If set to **Yes**, the display format is SSSSSDCMd.

13.8 Visualize penalty on displayboard

Each time selection is made, one of the two alternatives, **Yes** or **No** is activated. If set to **Yes**, when the competitor finishes, the time and penalties are displayed alternately on the displayboards configured to display only the time. When a penalty is assigned, the total value of penalties appears on the displayboard for a few seconds.

13.9 Max num in RollRank

This function is enabled if displayboards with rotating rankings are chosen. The maximum number of competitors in the rankings can be set by entering a value other than zero.

13.10 Displayboard available

This function makes it possible to select the displayboard to be used from the various alternatives and to assign it to an address.

| Hh:mm:ss.d Displ. Available ~€ | | | | |
|--------------------------------|-----------|------|-----|----------------|
| NUM | DISP.TYPE | ADDR | NUM | VISUALIZATION |
| ▶ 0 | Microtab | -- | 1 | Running Time |
| 1 | Microtab | -- | 1 | Rank Num |
| 2 | Microtab | 0 | 2 | Rnk Num T.Race |
| 3 | Microtab | -- | 2 | Athlet Name |

↑ ↓ Select Menu

Example of possible visualizations

In the column ‘**NUM**’ the progressive configuration number is shown.

In the column ‘**DISP.TYPE**’ the displayboard type is shown.

In the column ‘**ADDR NUM**’ the Address value to be set on the displayboard is shown if the configuration has been selected, otherwise the symbol -- appears. Remember that the displayboard Address values must correspond to the value indicated in this column.

In the column ‘**NUM**’ the number of displayboards set for the selected combination is shown.

In the column ‘**VISUALIZATION**’ the type of data which will be sent is indicated with abbreviations.

The active function keys are as follows:

- <F1> ↑ to scroll the list up
- <F2> ↓ to scroll the list down
- <F3> **Select** sets the address for the configuration indicated by ▶ If an already used address is set, the configuration which previously had the same address is deselected.
- <F5> **menu** to return to the configuration menu.

13.11 *Vis. delay dis./tick*

This function makes it possible to set the delay with which the tick is sent to the serial in ten thousandths of a second. If a LinkGate system is used for finishes, the minimum of 200ms is advisable to prevent the time displayed from running backwards, while for LinkPods 150ms is recommended.

13.12 *Displayb. Trans.length check*

Setting this function activates control of the length of the data transmitted to the displayboard. If the displayboard viewing choices made involve too great a quantity of data for the serial speed set, REI2 will show a warning and give the minimum speed that can be set. In this case, if the function is active REI2 refuses to allow quitting of the menu until the speed of the displayboard has been modified.

13.13 *Visualization pause RollRank*

This function is enabled if displayboards with rolling rankings are chosen. The display pause between the displayboard scrolls can be set.

14 Input Lines Setup

REI2 can receive impulses through various channels. As well as the line keys, the main lines (Start Lap Aux and Stop), the LinkGate radio system (with or without built-in radio system) and the LinkPod system can be used. For operational and connection modes, consult the User Manual.

14.1 Physical/logical Channel assignment

This menu allows you to specify how REI2 must interpret the signals coming from the various input devices.

14.1.1 Main lines and Keys assignment

This function allows you to change the types of events acquired both on the main lines (Start, Lap, Aux and Stop) and on the corresponding line keys.

The enabled function keys are:

- **<F1> logic Ch.** : each time you press, one of the possible options for the channel indicated by the symbol ◀ is enabled. The options possible are **STOP**, **N.ASS** for unassigned, **START** and **LAP** and **MANUAL** to only print the time event and not store it afterwards. If the LAP option is selected, REI2 asks which intermediate stage/lap, from 0 to 240, it must be assigned to. If set at 0, REI2 will automatically move the lap number forward with each impulse.
- **<F2> ↑↓** allows you to scroll the list of physical channels
- **<F3> ⇄** allows you to pass quickly from the line management column to the key management column
- **<F5> menu** to return to the configuration menu.



Although it is possible to change assignment of the physical channel of the keys, you are advised to do this only in cases of absolute necessity, taking great care after the modification has been made not to be misled by the characters on the keys.

14.1.2 Radio Channel assignment

This function allows you to change the event types acquired through the LinkGate radio system. The radio channels are presented on two distinct screen displays, the first from 0 (start) to 7 and the second from 8 to 15. (stop).

Initial assignment of radio channels is as follows:

- radio channel **0** as logical Start channel;
- radio channels from **1** to **9** as logical Lap channel from 1 to 9 and then, radio channels from **A** to **D** as logical channels from 10 to 13;
- radio channel **E** as generic Lap (Lap 0)
- radio channel **F** as logical Stop channel.

The enabled function keys are:

- **<F1> logic Ch.** : each time you press, one of the possible options for the channel indicated by the symbol ◀ is enabled. The options possible are **STOP**, **N.ASS** for unassigned, **START** and **LAP** and **MANUAL** to only print the time event and not store it afterwards. If the LAP option

is selected, REI2 asks which intermediate stage/lap, from 0 to 240, it must be assigned to. If set at 0, REI2 will automatically move the lap number forward with each impulse.

- <F2> ↑↓ allows you to scroll the list of radio channels
- <F3> ⇔ allows you to pass quickly from one column to another
- <F4> **Others** allows you to pass from the management of the channels from 0 (radio start) to 7 to the management of the channels from 8 to 15 (radio stop).
- <F5> **menu** to return to the configuration menu

14.1.3 Linkpod Channel assignment

As better described in the User Manual, the Microgate LinkPod © system consists of a series of from 1 to 10 ‘concentrators’ (pods) connected via cable. Depending on the type, each concentrator has up to 8 inputs making up a total of 80 lines.

This function allows you to assign the physical channel corresponding to each of the single pod inputs to a logical channel. Each pod is presented on its own screen display.

The enabled function keys are:

- <F1> **logic Ch.** : each time you press, one of the possible options for the channel indicated by the symbol ◀ is enabled. The options possible are **STOP**, **N.ASS** for unassigned, **START** and **LAP** and **MANUAL** to only print the time event and not store it afterwards. If the LAP option is selected, REI2 asks which intermediate stage/lap, from 0 to 240, it must be assigned to. If set at 0, REI2 will automatically move the lap number forward with each impulse.
- <F2> ↑↓ allows you to scroll the list of inputs of each LinkPod
- <F3> ⇔ allows you to pass quickly from one column to another
- <F4> **N.Pod** allows you to pass from the management of one LinkPod to another by inserting their respective numbers from 0, for the first, to 9
- <F5> **menu** to return to the configuration menu.

The number of LinkPods configured does not depend on the position of the cable but on the value set on each LinkPod.

14.2 Lines holdoff times

This allows you to edit the disactivation times of inputs after the acquisition of an event. Each line can be configured individually.

The enabled function keys are:

- <F1> ↑↓: allows you to scroll through the list of the various configurable lines. The line selected is indicated by the character ◀ and the disactivation time expressed in milliseconds can be inserted immediately
- <F2> ⇔ allows you to pass quickly from one column to another
- <F5> **menu** to return to the configuration menu.

The last lap value (the one at the bottom on the right) can be configured for the channel number as well as for holdoff time.

The disactivation value can adopt any value you like between 0 and 60,000 milliseconds (1 minute).

If you try to change the value for a channel for which there is no corresponding physical channel, for a few seconds the message ‘**Logical.chan not assigned to physical chan.!!!**’ appears.

14.3 Lines exclusion configuration

The <LCK> key situated over the <STA> button can be configured so as to offer the user the possibility of operating on one or more logical channels of his/her choice. (Vice versa, the <LCK> key over the <STO> button acts exclusively on the Stop logical channel). From this menu it is possible to select the lines on which the key is active. It is advisable to set the lines which are in fact controllable by the user.

The activation or disactivation of the <LCK> function on a line is shown by a filled in rectangle for lock enabled or an empty rectangle for lock disabled. A black blinking rectangle shows the position of the cursor.

The enabled function keys are:

- <F1> ←: allows you to move the cursor to the left on the various lines
- <F2> →: allows you to move the cursor to the right on the various lines
- <F3> **modify** : pressing this enables or disables sensibility to the <LCK> key for the line on which the cursor is positioned
- <F4> **N.lap** allows you to set the lap number of the last rectangle on the right. If the number 255 is entered, also the block on Stop can be set.
- <F5> **menu** to return to the configuration menu.

The <Rearm> key situated next to the <LCK> key operates on the same lines set for the <LCK> key.

14.4 Lines N/O N/C configuration

REI2 is designed to accept commands from devices which have contacts which are normally (at rest) either open or closed. From this menu it is possible to select the type of contact present on each of the main lines, both those connected through banana jack sockets or through standard din sockets.

The enabled function keys are:

- <F1> **Start**
- <F2> **Lap**
- <F3> **Stop**
- <F4> **Aux**
- <F5> **menu** to return to the configuration menu.

Each time the key associated with a line (from <F1> to <F4>) is pressed, one of the two options **Normally open** or **Normally closed** is enabled.

The Linkpod © inputs can be configured by acting directly on the device. For further information refer to the User Manual.

14.5 Noise filter principal lines

REI2 filters spurious events coming from external lines (e.g. start gates or switches).

The enabled function keys are:

- <F1> **Start**
- <F2> **Lap**
- <F3> **Stop**

- <F4> **Aux**
- <F5> **quit** to return to the configuration menu.

By default the noise filter is active on the Start line.

Every time the key assigned to a line is pressed (from <F1> to <F4>) one of the two options **Yes** – **No** is enabled.

15 Speed bases setup

This function is not available in the current version of this software.

16 Linkgate data upload

Microgate LinkGate Encoder's device for radio transmission of impulses allows you to transmit all the event times and speeds obtained during timing (up to a maximum of 256 times and 256 speeds) to REI2. This possibility enhances reliability as it enables you to 'retrieve' after an interval of time any times which for one reason or another have not been transmitted via radio.

With this function the data present in the encoder can be transferred to REI2.

After disconnecting the decoder and connecting the encoder with the dedicated cable (see User Manual), press <F1> to activate reception on REI2 and activate transmission on the encoder by pressing <2nd> and, keeping it pressed down, pressing the <SERIAL> key.

Within two seconds two counters will appear on the screen to indicate the number of times and speeds transmitted.

When you have finished transmission, on pressing <ENT> another menu will appear.

If you choose 'Absolute' (F1), the event times are simply transferred and shown in the same way as when they were acquired. It is therefore essential that the LinkGate Encoder device and REI2 have been synchronized (consult the User Manual) before beginning the timing session (if you do not want to have to make a laborious series of calculations and corrections later.....).

If you choose <F2> **Synchronization. Automatic** the two devices are synchronized after an interval of time, when the data are transferred.

In this way times are given their correct values even if the LinkGate Encoder and Racetime2 have never been synchronized. This second option is usually the most convenient one. However, it is indispensable that no change be made to REI2's synchronization in the time between the end of the timing session and the moment when data transfer is made. Similarly, it is better to transfer data immediately after the end of the timing session so as to reduce the deviation caused by the inevitable slight divergence between the time bases of the two devices (see the technical specifications of LinkGate Encoder and REI2 for an estimate of possible divergences).

You can print the times and speeds transferred from LinkGate Encoder, pressing <F1> to facilitate the assignment of times.

After choosing the time reference, you automatically enter the assignment function. With this operation, you can assign an event time transferred from LinkGate Encoder to an athlete's number for a certain run. The transferred times are shown in the fourth line of the display. The event times immediately before and immediately after the acquired time are shown in the third and fifth line respectively. In this way, it is easier to 'orientate' yourself amongst the times until you find the time or times you wish to retrieve. To pass from one time to the next without assigning them, press <ENT>. To scroll backwards and forwards through the acquired times, press <F1> or <F2>. To assign a time to a competitor number, insert the number directly, confirm with <ENT> and then insert the run number. If you try to assign a time already used, the stopwatch will show a warning signal.

The enabled function keys are:

- <F1> ↑: Allows you to scroll back up the list of events to be assigned

- <F2> ↓: Allows you to scroll down the list of events to be assigned
- <F3> **Homolo** / **All** / **Sta** / **Sto** Each time the key is pressed, one of the two time display modes is activated. **Homolo** displays only events of the same type (e.g. only Lap 1s, only starts, etc.). With **All**, the previous and following times are shown regardless of type.
- type; with **Sta/Sto** only the start and finish events are displayed
- <F5> **menu** to quit the function.

Example of Lap 1 acquisition:

| Hh:mm:ss.d Reception from LinkGate: | | | |
|-------------------------------------|----|------------|----------------|
| Event | N. | Man | Time |
| Lap 1 | 10 | 1 | 10:55:14.12_14 |
| Lap 1 | | | 10:57:12.54_85 |
| Lap 1 | 12 | 1 | 10:58:16.36_98 |
| Number: _____ | | Run: _____ | |
| ↑ | ↓ | Homolo | Menu |

In the example, after the Lap 1 signal for number 10, an unassigned signal appears, and then a signal for number 12.

So the time probably refers to the intermediate time of competitor 11.

Note: it is convenient to have an approximate idea of the time of the missing time event/events, possibly with the help of a printout of previous times.

17 Linkgate radio signal level

An essential condition for the correct use of the LinkGate system is a sufficiently high level of the quality of its radio signal. With this function, REI2 allows you to test its efficiency.

When you enter this function, the words '**RADIO SIGNAL QUALITY TEST**' appear, followed on the next line of the display by the words '**Ready to receive.....**'. At this point you can start a test transmission (for example, a start signal). After about 3 seconds from the start of transmission, during which the words '**Reception in progress.....**' is shown, the channel of the signal received and the quality of the signal expressed as a percentage are displayed. Naturally the higher the percentage, the higher the quality of reception.

Values above 40% are considered 'safe'.

If the channel set on the LinkGate Encoder does not coincide with the channel set on REI2 (see section LinkGate channel on p. 63), the message '**RADIO XXXX**

RADIO XXXX
Channel xxx Segnal= xxx%

Different channel received !!!!!

appears.

If the level of quality of the signal received is below 40%, one or more of the following steps can be taken:

- place both the transmitting and receiving radios (the radios connected to the Encoder) in an elevated upright position
- change the working frequency to avoid interference from the frequency used by other transmitters
- especially for the transmitting radio, use more efficient antennas such as $\frac{1}{4}$ or $\frac{5}{8}$ wave antennas instead of the normal 'charged' type

The antennas supplied with the integrated LinkGate EncRadio and LinkGate DecRadio transmission system already have a high level of efficiency.

Note: the quality signal test should preferably be performed with the 'short-long' selector of the LinkGate Encoder device in the 'Long' (L) position. If the selector is on 'Short' (S), the maximum 'quality' value indicated by the test is about 20%.

For further details about the LinkGate system, consult the User Manual.

With the <F5> **menu** function key, you return to the previous menu.

18 Time calculator

REI2 has a sexagesimal calculator.

18.1 Normal

Key in the first time you wish to add or subtract (TA); then key in the second time (TB).

The enabled function keys are:

- **<F1> A+B**: adds TA to TB
- **<F2> A-B**: subtracts TB from TA
- **<F3> edit** allows you to change the two set times
- **<F5> menu** to return to the previous menu.

The times are 'normalised' to 24 hours; for example, $2:00:00.000+23:00:00.000 = 1:00:00.000$ and not $25:00:00.000$.

Be careful when keying in thousandths, especially if the times to add or subtract are expressed with an accuracy of a tenth or a hundredth; for example, to insert the time 1:02.84 (one minute, two seconds, 84 hundredths), you must key in:

<0> <ENT> (hours)

<1> <ENT> (minutes)

<2> <ENT> (seconds)

<8><4><0><0> <ENT> (ten thousandths), and NOT **<8><4> <ENT>**.

18.2 Extended (day management)

Functioning is the same as for the normal calculator. In addition it offers you the possibility of inserting a figure for the day, thus allowing calculations on values which cover a number of days.

19 Set Modem

In this menu it is possible to communicate with a modem connected to REI2.

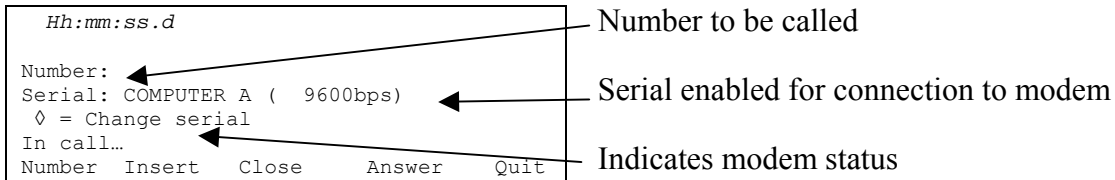

The active function keys are:

- **<F1> Number** allows you to insert the number to be called
- **<F2> Insert** to call the number inserted
- **<F3> Close** to interrupt communication with the modem
- **<F4> Answer** to reply to the external call
- **<F5> Quit** to return to the configuration menu.

To call an external number just connect the modem to the enabled serial output, insert the number to be called by pressing **<F1>** and keying in the single numbers in succession. Then when **<F2> Insert** is pressed, the text **In call....** will appear. If the number called replies, the connection is automatically activated.

When there is an external call, the text **In answer...** will appear. Press **<F4>** to activate connection to the modem.

20 Recharge batteries

During normal functioning, the presence of a valid external source of power supply (with a socket as symbol) or low battery condition (with the symbol of a battery) is shown in the display to the right of the first line. From the moment the symbol appears, about 90 minutes of autonomy remain.

Recharging of REI2's internal batteries is managed entirely by the microprocessor. In this way it has been possible to implement a recharge control which guarantees maximum efficiency of the batteries at all times, at the same time prolonging their operational life.

When you enter this function, the current state of power supply is shown on the sixth line of the display as follows:

- **'Battery in use ...'** the internal batteries are being used
- **'Maintenance'** the stopwatch is supplied by the external power source and at the same time the efficiency of the batteries is maintained by a weak charge current but they are NOT recharged
- **'Discharge...'** the internal batteries are being completely discharged before being subsequently recharged
- **'Battery recharge'** recharge in progress; on the right, the time remaining before the end of recharge is shown
- **'Recharge blocked'** recharge has been temporarily interrupted because of insufficient voltage. It will resume automatically as soon as a sufficient level of voltage is restored.

To recharge the batteries, connect a continuous 12-20 volt power source to the appropriate power point.



To recharge the batteries or completely discharge them, REI2 must remain switched on. During recharge it is possible to carry out every kind of timing. The important thing is not to switch it off

20.1 Discharge/recharge

When this function is selected, the internal batteries are first completely discharged and then recharged. This is the most correct procedure for keeping the internal batteries at maximum efficiency.

The duration of the discharge phase depends on how fully the batteries are charged and can last up to about 3 hours.

The duration of the subsequent recharge phase is 7 hours, at the end of which the message **'RECHARGE OK!'** appears.

20.2 Immediate recharge

If it is not possible to charge or recharge in the correct way because of lack of time or for any other reason, it is possible just to recharge. In this way recharge time is reduced but this procedure is not recommended as it reduces the efficiency of the batteries.

20.3 Break

With this function the discharge and recharge phases are interrupted. REI2 returns to maintenance status.

21 Race management

REI2 can memorise up to 8 different races and their relative configurations. It is possible to suspend a race at any moment, to manage a different one and then to retrieve the suspended race.

As soon as REI2 has finished checking synchronization and memory content it activates the race management menu.

At the end of timing, no operation is necessary to memorise a race. All the data is automatically recorded in the stopwatch's memory and retained also when the machine is switched off. For stored data retention times, consult the User Manual.

21.1 New race

Selecting this option allows you to start a new race. You are asked for the program to be used and when you have selected this, you are given the indication '**NEW RACE**' and the number assigned on the printout.

If all the eight races available have been stored, the message '**ATTENTION! – Race Memory Full – Delete one or more races – Press a key to continue**' appears and you must delete one of the stored races to be able to continue.

21.2 Delete/Recall stored race

This option allows you to retrieve or delete a previously stored race from the list of races proposed.

In the column

- **RACE** the progressive race number appears. The symbol * to the left of the number indicates the last active race, which is retrieved if Continue current race is selected
- **DATE** the start date
- **START** the start time
- **TYPE** the type of program used for the race.

The positions which are free for memorising a race are indicated by '---'

The enabled function keys are

- <F1> ↑: to scroll the race list up
- <F2> ↓: to scroll the list down
- <F3> deletes the race shown by the symbol ◀. You are requested to confirm that you wish to delete the race, <F4> to delete, <F5> to annul deletion. If you select an unused race number, the message '**Impossible to delete**' appears
- <F4> retrieves the race indicated by the symbol ◀ and allows you to resume timing it. If you select an unused race number, the message '**Race not available**' appears.
- <F5> to return to the previous menu.

21.3 Continue current race

By selecting this option, you resume timing of the last race stored, and retain all its timings and configuration settings.

| | | |
|---|------------------------------|--|
|  | REI2 Show Jumping Program | Doc: R2U_E_1079_002_E Version: 1.07.9 Page 85 of 103 |
|---|------------------------------|--|

21.4 Clear all memory

Selecting this option allows you to delete all the data of all the stored races. On the display the message ‘***** ATTENTION ***** - **All data and races will be deleted in an irreversible way, continue?**’ Press <F4> for **Yes** to delete all the stored races, press <F5> for **No** to annul the deletion operation.

22 Modify basic configuration

This function is not available in the current version of this software.

23 Line status

This function allows convenient management of the status lines connected to REI. To the right of their description, the main lines, Start, Lap, Stop and Aux have a little circle which indicates their status. For the Pods of the LinkPod system, the status of each of the 8 inputs of each Pod is indicated.

The indicators mean:

- Empty circle Line at rest
- Full circle Line active
- Line (only Pod) Pod not present or not correctly connected or line not physically present on the Pod (Pod with fewer than 8 inputs).

24 Pre-set configurations

The table below summarises the standard settings activated when one of the competition types is selected¹:

| | Phase: single | Phase: 2 (both progressive and separate time) | Phase: Consecutive barrage |
|---|----------------------|--|---|
| Initial countdown signal | LAP (E) | LAP (E) | LAP (E) |
| Start of first phase signal | START (0) | START (0) | START (0) |
| Single phase intermediate signal | AUX (1) | | |
| Phase 1 finish signal | | STOP (F) | STOP (F) |
| Phase 2 start signal | | | START (0) |
| Phase 2 intermediate signal | | AUX (1) | AUX (1) |
| End of race signal | STOP (F) | STOP (F) | STOP (F) |
| Count suspension signal | LAP (E) | LAP (E) | LAP (E) |
| Count resumption signal | LAP (E) | LAP (E) | LAP (E) |
| Phase 1 countdown | 45 sec | 45 sec | 45 sec |
| Phase 1 maximum time | 60 sec | 60 sec | 60 sec |
| Phase 1 time limit | 120 sec | 120 sec | 120 sec |
| Phase 1 – phase 2 interval | | | 15 sec |
| Phase 2 countdown | | 45 sec | 45 sec |
| Phase 2 maximum time | | 60 sec | 60 sec |
| Phase 2 time limit | | 120 sec | 120 sec |
| Eliminate after first phase if penalized | | Si | Si |
| Phase 1 FISE table | A | A | A |
| Phase 2 FISE table | | A | A |
| Preset penalties <F1>,<F2>,<F3> | 3,4, 8 points | 3,4, 8 points | 3,4, 8 points |
| Preset time correction <F1>,<F2>,<F3> | 3,4,5 sec. | 3,4,5 sec. | 3,4,5 sec. |
| Tab. A penalty for exceeding maximum time | 1 points | 1 points | 1 points |
| Tab. C penalty for exceeding maximum time | 1 sec | 1 sec | 1 sec |

¹ For the various signals the ‘Signal type’ to be set on the radio encoder, if used, is indicated in brackets.

25 REI2 – PC communication protocols

25.1 From PC

To transmit information about athletes' names and nationalities and the composition of groups, and start lists, a file must be compiled for each of these functions. Within each line the various values are separated by the ASCII Tab (09h) character and the various lines by the character CR (13) (0Dh). The key words (highlighted in **bold**) should be sent exactly as they are written.

Data can only be sent to the Computer A output of the REI2 stopwatch. Transmission can also be made in background, and so without entering the menu data reception from PC.

25.1.1 List of athletes' names and nationalities

The list of the athletes' names and nationalities specifies the assignment of a competitor number and a particular name. Each assignment is placed on a different line of the text, and the complete format is as follows:

| | |
|-----------------|--|
| \$STARTL | Start of list of names, must be written exactly as it appears here at the side |
| CR | Carriage Return (0Dh) |
| | The following information is repeated for each competitor inserted: |
| comp.no | Athlete's number (e.g. 1) |
| TAB | Tabulator (09h) |
| nat | Nation abbreviation of three characters (e.g. ITA) |
| TAB | Tabulator (09h) |
| name | First name and surname (max 24 characters), only one space is allowed between first name and surname (e.g. Isolde Kostner); compound names can also be sent by using _ to divide the name. E.g.: Marco_Andrea Di_Luca. |
| CR | Carriage Return (0Dh) |
| | End of repeated part of information about competitor |
| \$STOPL | End of list. Indicates to REI2 that the list of names is finished |
| CR | Carriage Return (0Dh) |

→ **\$STARTL** CR ——— comp.no TAB nat TAB name CR ——— **\$STOPL** CR →

Example:

| | |
|----------------------|--|
| \$STARTL | Start of list of names, must be written exactly as it appears here! |
| 1 ITA Isolde Kostner | Assignment of competitor number 1 to the Italian athlete Isolde Kostner. |
| \$STOPL | End of list. Indicates to REI2 that the list of names is finished. |

REI2 also offers the possibility of displaying the names of the horses as well as those of the riders on the displayboards. The name of the horse is assigned to a competitor number calculated by adding 1000 to the rider's competitor number.

Example: N° rider: 24; N° horse: 1024.

25.1.2 List of groups and their composition

It is possible to define a list of groups and their composition and send it to REI2. The format is very similar to the list of names.

| | |
|-----------------|---|
| \$STARTG | Start of list of names, must be written exactly as it appears here at the side |
| CR | Carriage Return (0Dh) |
| | For each group to be inserted the selection of the group should be repeated |
| G | Group marker |
| TAB | Tabulator (09h) |
| gn | Group number(max number allowed 200) |
| CR | Tabulator (0Dh) |
| | For each selection of each group, specification of the details of the selection should be repeated |
| in | Initial number of choice of group |
| TAB | Tabulator (09h) |
| fn | Final number of choice of group |
| CR | Carriage Return (0Dh) |
| | End of repeated part of information about choice of group |
| | End of repeated part of information about selection of group |
| \$STOPG | End of group list. The maximum number of choices for each group is 10. The maximum number of groups which can be set is 98. Number 99 is reserved for internal use and means 'all groups' |
| CR | Carriage Return (0Dh) |

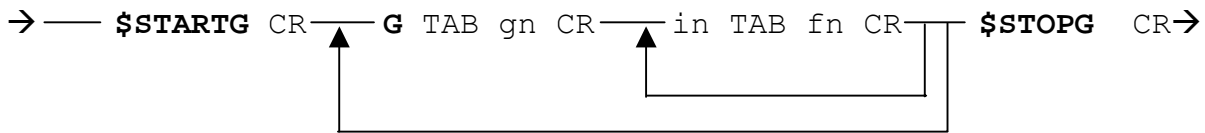

Example:

| | |
|----------|---|
| \$STARTG | Start of group list |
| G 1 | Definition of Group 1 |
| 1 100 | First choice group1: from 1 to 100 |
| 101 200 | Second choice group 1: from 101 to 200 |
| 251 300 | |
| 387 387 | |
| G 2 | End of group 1, start of group 2 |
| 400 415 | |
| 460 485 | |
| 500 530 | |
| 654 654 | To insert an individual competitor number, insert the same number twice |
| \$STOPG | End of Groups list |

25.1.3 Start Lists

The start list specifies the athletes' starting order for each run of the race. A run can be defined as a run with single starts or group starts.

The format of the list is as follows:

| | |
|-----------------|---|
| \$STARTP | Start of start list |
| CR | Carriage Return (0Dh) |
| | For each run to load, repeat the following part |
| MS | Start of Run 1, for single starts |
| TAB | Tabulator (09h) |
| Rn | Run number |
| CR | Carriage Return (0Dh) |
| | Repeat numbers at start |
| Comp.no | Start: number at start |
| CR | Carriage Return (0Dh) |
| | End of repetition of number |
| | End of repetition of run |
| \$STOPP | End of start list |
| CR | Carriage Return (0Dh) |

The maximum number of runs which can be set is 8. The runs can be either 'single' starts or group starts.

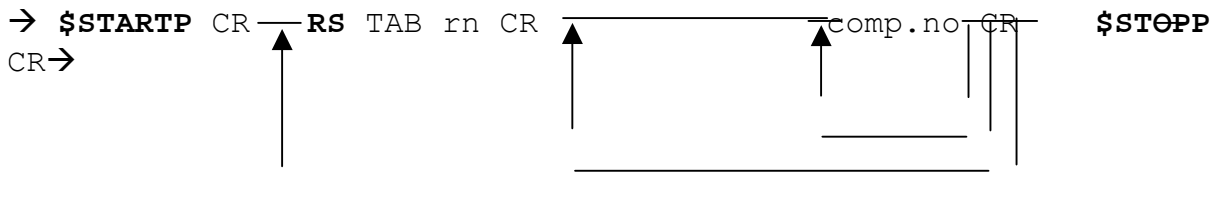

Example:

| | |
|----------|------------------------------------|
| \$STARTP | Start of start list |
| RS 1 | Start of Run 2, for single starts |
| 1 | First Start: Competitor number 1 |
| 32 | Second Start: Competitor number 32 |
| 31 | Third Start: Competitor number 31 |
| 40 | ... |
| 51 | |
| \$STOPP | End of start list |

25.2 For PC

By using appropriate protocols, it is possible to ask REI2 for a series of items of information stored in its memory, such as net times and time events, running times and the status of competitors. The details and specifications of communication are given in **Communication protocols**. No command sent through the connectors computers A and B can change the data present in the stopwatch apart from those specified, which, in any case, have to be confirmed on REI2.

For connection between REI2 and computer, use the ports 'Computer A' and 'Computer B'.

26 Menu structure

26.1 Initial menu

- A: New race
 - A: Single starts
 - B: Group starts
 - C: Basic stopwatch
 - D: Parallel
- Other
 - A: Show jumping
 - B: Swimming
 - C: PC-ONLINE
 - D: Dual Time
- B: Delete/Retrieve stored race
- C: Continue current race
- D: Total memory deletion
- Other
 - A: Battery recharge
 - A: Discharge/recharge
 - B: Immediate recharge
 - C: Interrupt
 - B: LinkGate radio signal level test
 - C: Line status (main and pod)
 - D: Autotuning battery

26.2 Race menu

The entries indicated with ⁽²⁾ are only available for 2 progressive time phases, those indicated with ^(S) for the two phases with separate times, those with ^(C) for consecutive barrage.

(M 1)

| | |
|---|--|
| M 1.A: Timing | 2.3 Timing 10 |
| M 1.B: Print/insert groups | 5 Group management 38 |
| M 1/2.A: Insert/Edit groups | 5.1 Input/Modify groups 38 |
| M 1/2.B: Print group structure | 5.2 Print groups structure 39 |
| M 1/2.C: Delete groups | 5.3 Clear groups structure 39 |
| M 1/2.D: Groups structure:... | 5.4 Groups structure: 39 |
| other | |
| M 1/2b.A: Upload group structure from PC | 5.5 Uploading group structure from PC 40 |
| M 1.C: Rankings and other printouts | 6 Rankings and other printouts 41 |
| M 1/3.A: Print/display rankings | 6.1 Print/Show ranking 41 |
| M 1/3.B: Other printouts | 6.2 Other printouts 42 |
| M 1/3/2.A: Time events | 6.2.1 Time of day 42 |
| M 1/3/2.B: Eliminated | 6.2.3 Eliminated Printout 43 |
| M 1/3/2.C: Starters in run | 6.2.2 Started in run 43 |
| M 1/3/2 D: Run | 6.2.2 Started in run 43 |
| M 1/3.C: Print and display modes | 6.3 Printout and visualization mode 43 |
| M 1/3/3.A: Data display: | 6.3 Printout and visualization mode 43 |
| M 1/3/3.B: Print gap : | 6.3 Printout and visualization mode 43 |
| M 1/3/3 C: Sort same time : ... | 6.3 Printout and visualization mode 43 |
| M 1/3/3 D: Send printout on serial:... | 6.3 Printout and visualization mode 43 |
| other | |
| M 1/3/3b.A: Take previous laps:... | 6.3 Printout and visualization mode 43 |
| M 1/3/3b.B: Max athletes in ranking ... | 6.3 Printout and visualization mode 43 |
| M 1/3/3b.C: Print competitors' names: ... | 6.3 Printout and visualization mode 43 |
| M 1/3/3b D: Printout compet. nation : ... | 6.3 Printout and visualization mode 43 |
| M 1 D Start management | 7 Departure manager 44 |
| M 1/4 A: Man. insertion of start order | 7.1 Input start list 44 |
| M 1/4 B: Start order calculation | 7.2 Start order calculation 45 |
| M 1/4 C: Print start lists | 7.3 Print start lists 48 |
| Others (M 2) | |
| M 2.A: Synchronization | 8 Synchronization 49 |
| M 2/1.A: Synchronization | 8.1 Synchronization 49 |
| M 2/1.B: Edit synchronization value | 8.2 Editing synchronization value 49 |
| M 1/3 C: Synchronization verify | 8.3 Synchronization verify 49 |
| M 1/3 D: Signal ... | 8.4 Signal 49 |
| M 2.B: Eliminations | 9 Eliminations 51 |
| M 2.C: Data transmission to PC | 10 Download data to to PC 52 |
| M 2/3 A: Off-line data transmission | 10.1 Off-Line data transmission 52 |
| M 2/3 B: On-line data output configuration | 10.2 On Line data output setup 52 |
| M 2/3/C: Serial configuration | 12.3 Serial ports setup 64 |
| M 2/3 D: Output protocol:... | 10.3 Data output protocol 53 |
| M 2 D: Data upload from PC | 11 Upload data from PC 54 |
| M 2/4 A: Upload of lists from PC | 11.1 Upload data from PC 54 |
| M 2/4/1.A: Upload of competitor lists from PC | 11.1.1 Upload of competitor lists from PC 54 |

| | |
|--|---|
| M 2/4/1.B: Upload of group structure from PC | 11.1.2 Upload groups structure from PC 54 |
| M 2/4/1.C: Upload of start list from PC | 11.1.3 Upload start lists from PC 54 |
| M 2/4.B: Print lists | 11.2 Printout lists 55 |
| M 2/4/2.A: Print competitors' list | 11.2 Printout lists 55 |
| M 2/4/2.B: Print group structure | 5.2 Print groups structure 39 |
| M 2/4/2.C: Print start lists | 11.1.4 Printouts lists 55 |
| M 2/4.D: Delete lists | 11.3 Delete lists menu 55 |
| M 2/4/3.A: Delete list of competitors' names | 11.3.1 Delete competitor name lists 55 |
| M 2/4/3.B: Delete group structure | 11.3.2 Delete groups structure 56 |
| M 2/4/3.C: Delete start list | 11.3.3 Delete start lists 56 |

Others (M3)

| | |
|--|--|
| M 3.A: REI2 configuration | 12 REI2 setup 57 |
| M 3/1.A: Software configuration | 12.1 Software setup 57 |
| M 3/1/1 A: Phase:... | 12.1.1 Ph 57 |
| M 3/1/1 B: Penalty settings | 12.1.2 Penalty settings 57 |
| M 3/1/1 C: Table Ph1/sing.:... | 12.1.3 Table Ph1/sing. 57 |
| M 3/1/1 D: Add previous runs | 12.1.7 Add previous runs 58 |
| M 3/1/1 D: Table Ph 2 ^(2,S,C) | 12.1.4 Table Phase 2 58 |
| (Others) | |
| M 3/1/1b A: Ph 1/single:... | 12.1.5 Maximum time penalty - phase1/single 58 |
| M 3/1/1b B: Ph 2:... | 12.1.6 Maximum time penalty - phase 58 |
| M 3/1/1b C: Take delay after countdown:... | 12.1.8 Take delay after countdown 58 |
| M 3/1/1b D: Ranking based on ⁽²⁾ | 12.1.9 Ranking based on 58 |
| M 3/1/1b D: Pause Ph1..Ph2 ^(C) : | 12.1.10 Phase 1-phase 2 59 |
| (Others) | |
| M 3/1/1c A: Finish signals | 12.1.11 Finish signals 59 |
| M 3/1/1c B: Start t | 12.1.12 Start time 59 |
| M 3/1/1c C: Max T. | 12.1.13 Maximum 59 |
| M 3/1/1c D: T.Limit | 12.1.14 Time limit value 60 |
| (Others) | |
| M 3/1/1d A: Delete after first phase: ^(2,S,C) | 12.1.15 Delete after first phase: (2,S,C) 60 |
| M 3/1/1d B: Start T. Ph2. ^(2,S,C) | 12.1.16 Phase 2 start time (2,S,C) 60 |
| M 3/1/1d C: Max T. Ph2 ^(2,S,C) | 12.1.17 Phase 2 maximum time (2,S,C) 60 |
| M 3/1/1d D: T. Limit Ph2 ^(2,S,C) | 12.1.18 Phase 2 time limit (2,S,C) 60 |
| (Others) | |
| M 3/1/1e A: Display countdown on display:.. | 12.1.19 Visualize countdown on displayboard 60 |
| M 3/1/1e B: Print Time of Day:... | 12.1.20 Print Time of day 60 |
| M 3/1/1e C: Alarm:... | 12.1.21 Sound counter 61 |
| M 3/1/1e D: Auto lines block after every event: | 12.1.22 Auto lines block after every event 61 |
| (Others) | |
| M 3/1/1f A: Carry over points to 2nd phase:... | 12.1.23 Take point for 2nd phase 61 |
| M 3/1/1f B: Sub penalty if T>Tmax:... | 12.1.24 Subtract penalty if T>Tmax 61 |
| M 3/1/1f C: Consider 0 points as 1 st :... | 12.1.25 Consider 0 point 61 |
| M 3/1/1f D: Measurement precision | 12.1.26 Time accuracy 62 |
| M 3/1/1f/4 A: Measurement precision | 12.1.26 Time accuracy 62 |
| M 3/1/1f/4 B: Rounding off | 12.1.26 Time accuracy 62 |
| M 3/1/1f/4 C: Time event truncation | 12.1.26 Time accuracy 62 |
| (Others) | |
| M 3/1/1g A: Race to point | 12.1.3 Table Ph1/sing. 57 |
| M 3/1/1g B: Start without countdown | 12.1.28 Start without countdown 62 |
| M 3/1/1g C: Point accuracy | 12.1.29 Point accuracy 63 |
| M 3/1/1g D: Add on displayb. T.C. at the end | 12.1.30 Add on displayb. T.C. at the end 63 |

| | |
|---|---|
| M 3/1.B: Hardware configuration | 12.2 Hardware setup 63 |
| M 3/1/2.A: LinkGate channel: ... | 12.2.1 LinkGate channel 63 |
| M 3/1/2.B: Printer on: ... | 12.2.2 Printer on 63 |
| M 3/1/2.C: Beep keys: | 12.2.3 Keys beep 63 |
| M 3/1/2.D: Display contrast | 12.2.4 Display contrast 64 |
| Others | |
| M 3/1/2b A: Linkgate transmission duration:.. | 12.2.5 LinkGate transmission length 64 |
| M 3/1.C: Serial configuration | 12.3 Serial ports setup 64 |
| M 3/1.D: Print configuration | 12.4 Printout Stopwatch setup 65 |
| | |
| M 3.B: Displayboard configuration | 13 Displayboards setup 66 |
| M 3/2.A: Selecting display | 13.1 Virtual scoreboard 66 |
| M 3/2.B: Display pause | 13.2 Visu. pause 69 |
| M 3/2 C: Serial velocity of displayboard.= | 13.3 Serial speed displayboards 69 |
| M 3/2 D: Advertising program:... | 13.4 Spot program 69 |
| other | |
| M 3/2b A: Display nation. | 13.5 Visualization nation 69 |
| M 3/2b B: Line 485 configuration | 13.6 Configuration line 485 70 |
| M 3/2b C: Display time without points | 13.7 Visualize time without point 70 |
| M 3/2b D: Display penalties on displayboard | 13.8 Visualize penalty on displayboard 70 |
| Others | |
| M 3/2c A: Displayb. trans.length check:... | 13.12 Displayb. Trans.length check 71 |
| M 3/2c B: Displayboard available | 13.10 Displayboard available 70 |
| M 3/2c C: Vis. delay dis./tick: | 13.11 Vis. delay dis./tick 71 |
| Altro | |
| M 3/2c A: Max num in class. Rot | 13.9 Max num in RollRank 70 |
| M 3/2d B: Visualization pause RollRank:... | 13.13 Visualization pause RollRank 71 |
| | |
| M 3 C: Line configuration | 14 Input Lines Setup 72 |
| M 3/3.A: Assignment of physical/logical channels | 14.1 Physical/logical Channel assignment 72 |
| M 3/3/1.A: Assignment of main lines and keys | 14.1.1 Main lines and Keys assignment 72 |
| M 3/3/1.B: Radio Channel assignment | 14.1.2 Radio Channel assignment 72 |
| M 3/3/1.C: LinkPod Channel Assignment | 14.1.3 Linkpod Channel assignment 73 |
| M 3/3.B: Line disactivation times | 14.2 Lines holdoff times 73 |
| M 3/3.C: Line exclusion configuration | 14.3 Lines exclusion configuration 74 |
| M 3/3.D: Configuration of N/O N/C lines | 14.4 Lines N/O N/C configuration 74 |
| | |
| M 3.D: Setting of speed bases (disab.) | 15 Speed bases setup 76 |
| | |
| Others (M 4) | |
| | |
| M 4.A: Aquisition of data stored by LinkGate (disab.) | 16 Linkgate data upload77 |
| | |
| M 4.B: LinkGate radio signal level test | 17 Linkgate radio signal level 79 |
| | |
| M 4.C: Calculator | 18 Time calculator 80 |
| M 4/3.A: Normal | 18.1 Normal 80 |
| M 4/3.B: Extended (day management) | 18.2 Extended (day management) 80 |
| | |
| M 4.D: Battery recharge | 20 Recharge batteries 82 |
| M 4/4.A: Discharge/recharge | 20.1 Discharge/recharge 82 |
| M 4/4.B: Immediate recharge | 20.2 Immediate recharge 82 |
| M 4/4.C: Interrupt | 20.3 Break 83 |

Others (M 5)

M 5.A: Race management-→ return above.

A: New race 21.1 New race 84

B: Delete/retrieve stored race

C: Continue current race

D: Total memory deletion

21 Race management 84

21.2 Delete/Recall stored race 84

21.3 Continue current race 84

21.4 Clear all memory 85

M 5.B: Edit basic configuration

22 Modify basic configuration 86

M 5.C: Line status

23 Line status 87

M 5 D Semaphore

See relative manual

Other (M 6)

M 6 A: Rei2 net

Function currently unavailable

M 6 B: Rei2 Net Setup

Function currently unavailable

27 Editing history

The table below summarises the main changes made to this document.

| Program version | Chapter | Page | Editing description |
|------------------------|----------------|-------------|---|
| 1.03 | | | The first version of this manual is for the version 1.03. |
| 1.07.9 | | | General edit for version 1.07.9 |

A

28 Course types

| Function | Radio signal | Input line | Diagram ref. |
|--|---|--|-----------------------|
| Beginning of start countdown (if required) | Lap E | Lap | |
| Start of horse | Start | Start | |
| End of ride (configurable signal) | Stop or Start | Stop or Start | A, C, D, E, G B, F |
| Intermediate time, only in 'single phase' or second phase in '2 phase' mode or 'Consecutive barrage' mode | Lap 1 | Aux | |
| Finish of phase 1 and start of second phase, only in the '2 phases, progressive time' and '2 phases, separate times' modes (configurable signal) | Lap 1 or Start or Stop | Aux or Start or Stop | C, G D, F E |
| Start of second phase (only for the 'Consecutive barrage' mode (configurable signal) | Lap 1 or Start or Stop or Lap 2 | Aux or Start or Stop (Lap 2 is not available via cable) | G |
| Interruption and resumption of timing by the judge | Lap E | Lap | |

'Single phase' mode

A : Separate start and finish

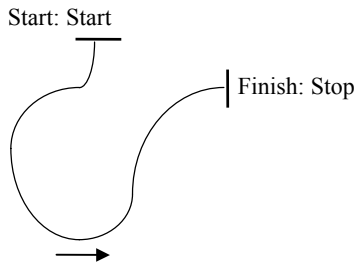

B : Coinciding start and finish

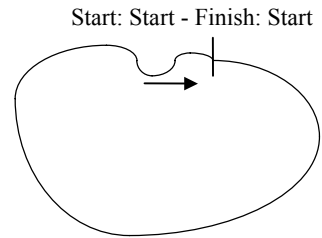

'Two phases' mode

C : Start, phase 1/2 and separate finish

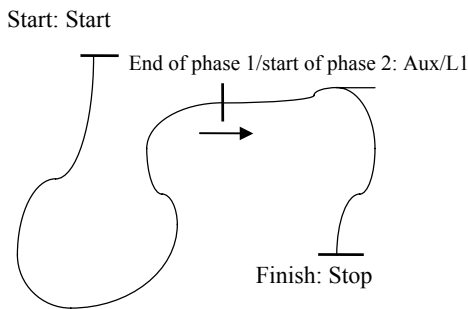

D : Start coinciding with phase 1/2

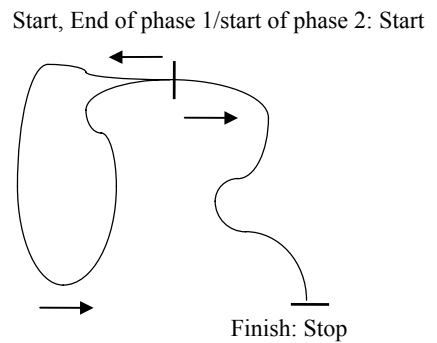

E : Finish coinciding with phase 1/2

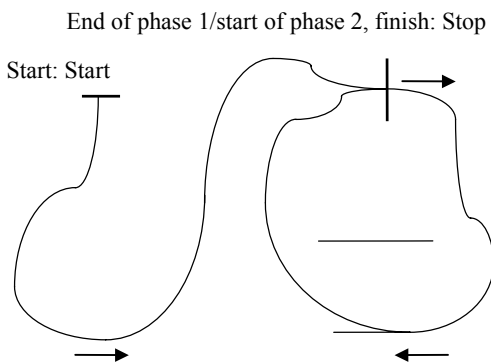

F : Start: coinciding finish and phase 1/2

Start, end of phase 1/start of phase 2, finish: Start

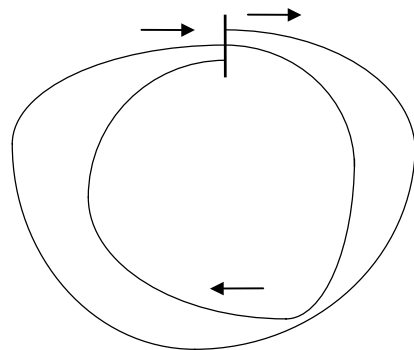

**G : 'Consecutive barrage' mode
with start and finish in two different points of the course**

Figure 13 – Configuration examples

| | | |
|---|------------------------------|---|
|  | REI2 Show Jumping Program | Doc: R2U_E_1079_002_E Version: 1.07.9 Page 103 of 103 |
|---|------------------------------|---|

Copyright

Copyright © 1999, 2006 by Microgate s.r.l.
All rights reserved

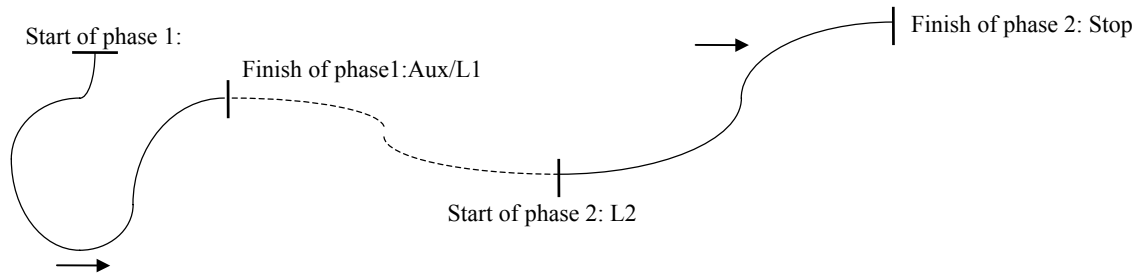
No part of this document or of any of the individual manuals may be copied or reproduced without previously making a written application to Microgate s.r.l. for authorisation.

All the marks or names of products mentioned in this document or in the individual manuals are or may be registered marks belonging to the individual firms.

Microgate, REI2, REI, RaceTime, MicroTab, μ Tab, MicroGraph, μ Graph, MicroBeep, μ Beep, Uploader, Microrun, MicroLink, μ Flasher, LinkPod, LinkGate, LinkGate encoder, LinkGate decoder, EncRadio, DecRadio, Polifemo, MicroSem, μ Sem, are registered marks of Microgate s.r.l. or of licensed users.

Microgate s.r.l. reserves the right to modify the products described in this document and/or in the relative manuals without notice.

Collaborators in the creation of REI2 and the preparation of the relative manuals are:

Ing. Roberto Biasi,
Dr. Vinicio Biasi
Ing. Federico Gori
Ing. Alessandro Miorelli
Giuliano Menestrina
Daniele Veronese
Claudio Zanella

The software and manuals are available in the following languages: Italian, English, German and French.

Microgate S.r.L
39100 Bolzano - Bozen
Via Stradivari 4, Stradivaristr.
ITALY

Tel. +39 471 501532 - Fax +39 471 501524
e-mail info@microgate.it

